



FULL INVERTER

SWIMMING POOL HEAT PUMP

Installation and user manual



SILVER INVERTER PRO COMPACT / SPLIT

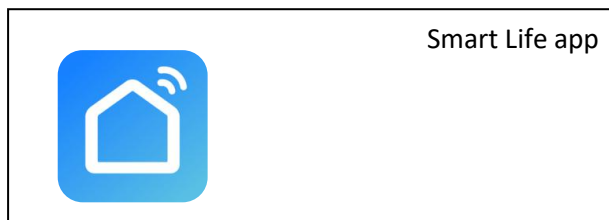

Smart Life app

Models:
HP1100
HP1500
HP1800
HP2100
HP2800

Please read this manual carefully
before installation, operation or maintenance.

Version: V03/2025

Contents

1. PREFACE	1
1.1. Safety	1
2. OVERVIEW OF THE HEAT PUMP	4
2.1. Transportation	4
2.2. Accessories	5
2.3. Technical Parameter	6
2.4. Unit Dimensions	8
3.1. Installation Distance	9
3.2. Installation of Drain Hose	9
3.2. Installation of Water Connection	9
3.3. Installation of Water Pipe - Compact	10
3.4. Layout of Water System	10
b. Electricity Connection	12
Split – connection between the units	12
TESTING	13
4.1. Inspection	13
4.2. Trial Running	13
5. Touch controller	14
5.1. Icon and Key Description of Wire Controller	14
5.1.1. Icon Description	14
5.1.2. Key Description	15
5.1.3. Combination Keys Description	15
5.2. Operation Instruction of Wire Controller	16
a. Heating/Cooling/Auto	16
Operating Parameter List	17
5.2.6. Faults Display	18
5.2.7. Clock Setting	19
5.3. Operation Instruction of Wi-Fi Function	22
5. SPLIT – connection and installation	34
6. MAINTENANCE AND WINTERIZING	39
6.1. Maintenance	39
6.2. Winterizing	40
Warranty	41

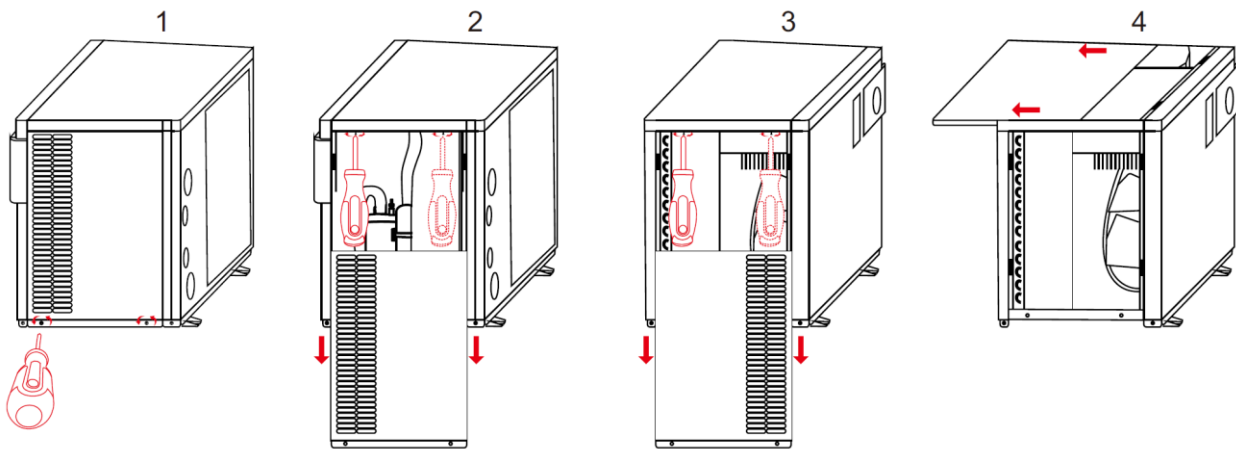

Model	Max rated current	Power Supply	Main power supply cable (Max. Recommend Value)	Circuit breaker	Split signal cable
HP1100 SILVER INVERTER PRO	10.5A	220-240V~/ 50Hz	3G 2.5mm ²	16A	4x 0.5mm ²
HP1500 SILVER INVERTER PRO	14.5A		3G 4.0mm ²	20A	4x 0.5mm ²
HP1800 SILVER INVERTER PRO	17.3A		3G 4.0mm ²	20A	4x 0.5mm ²
HP2100 SILVER INVERTER PRO	20.0A		3G 4.0mm ²	25A	4x 0.5mm ²
HP2800 SILVER INVERTER PRO	26.9A (3x9)	380-415V/3N~/50Hz	5G 2.5mm ²	16A 3f	4x 0.5mm ²

Split





Heat pump model	Pipe size				Factory pre-charged connection distance	Nominal charge g R32	Max. vertical distance (B)	Max. distance (A)	Additional refrigerant for 1m (above 0m)	Maximum charge g R32
	Gas (diameter)		Liquid (diameter)							
	inch	mm	inch	mm						
HP1100	1/2	12.70	1/4	6.35	0m	600g	15m	25m	25g/m	1.225g
HP1500	5/8	15.88	3/8	9.52	0m	800g	15m	25m	35g/m	1.675g
HP1800	5/8	15.88	3/8	9.52	0m	850g	15m	25m	45g/m	1.975g
HP2100	5/8	15.88	3/8	9.52	0m	1150g	15m	25m	45g/m	2.275g
HP2800	3/4	19.05	3/8	9.52	0m	1350g	15m	25m	60g/m	2.850g

1. PREFACE

Thank you very much for purchasing our heat pump. We sincerely hope that the product can provide you with a comfortable user experience. by starting, please read this manual thoroughly and keep it carefully for future usage and maintenance.

Symbol

Listed below are some important symbols that should be strictly followed.

	<p>The refrigerant used in this equipment is flammable. Refrigerant exposure to an external source of ignition is possible to cause a fire hazard.</p>
	<p>Carefully read this manual before any operation.</p>
	<p>This manual comes with critical information on installation, operation, and maintenance.</p>
	<p>Service personnel should refer strictly to this manual for the installation, operation, or maintenance of the equipment.</p>





1.1. Safety

- a. Please keep the main power switch away from children and avoid children's contact.
- b. Please turn off the main power in thunderstorm weather to avoid equipment damage or short circuit.
- c. It is forbidden to light an ignition source near the equipment during its operation.
- d. If the refrigerant leakage occurs during installation or usage, any operation should be stopped immediately and a service man should be called for inspection.
- e. Do not put your fingers into the air vent. The fan running at high speed will cause serious injury.
- f. Do not touch the edges and fins to prevent from being cut.
- g. Do not operate this equipment with wet hands to prevent electric shock.
- h. For the safety of the user, it must be properly connected to the ground to prevent the risk of electric shock in case of leakage of electricity.

- i. Do not touch the refrigerant pipeline with your hands to avoid scald.
- j. If high-temperature work is to be performed on this product, appropriate fire extinguishing device, such as dry powder or carbon dioxide fire extinguishers, should be available.
- k. Do not clean the machine while the power is on. Please turn off the power before cleaning. Otherwise, it may cause injury due to the high-speed fan or electric shock.

Warning

- a. For repairs please contact a service man. The repair process must be done in strict accordance with this manual. All maintenance operations by non-professional personnel are prohibited.
- b. Misoperation may result in injury to personnel or damage to equipment.
- c. Please make sure that water flow is built up before starting the unit. It is forbidden to start this equipment before the water flow has been established. Otherwise, there is a risk of damage to this equipment.
- d. In winter or when the ambient temperature drops below 0°C, be sure to empty the water from the heat pump if it is not in use. Otherwise, the unit will be damaged by freezing, in which case your warranty will be voided.
- e. When there is a need to cut the power for repair, wait for 1 minute after power is off before touching the circuit board, to avoid capacitor discharge resulting in electric shock.
- f. The heat pump must be stored and transferred vertically in its original packaging. If this is not feasible, it cannot be operated immediately after it has been properly placed and must wait at least 24 hours before being powered on.
- g. This equipment is not intended for direct use by children. Children must be supervised by an adult while using it to ensure their safety.
- h. The correct power supply, voltage, and frequency must be confirmed before installation.
- i. Please connect the power cord accurately according to the wiring diagram in this manual to avoid burning the unit or catching fire.
- j. Improper installation may result in fire, electric shock, equipment falling, or water leakage.
- k. Make sure no water penetrates the electrical components.
- l. It is forbidden to store flammable, explosive, and toxic substances in the place where the unit is used to prevent accidents such as fire or explosion.
- m. Please do not place objects that will obstruct the airflow near the air inlet and outlet. Otherwise, it will affect the efficiency of the equipment and even cause the equipment to report malfunction and stop operation.
- n. Do not use any method to speed up the defrosting process or to clean the frosted parts, as this will cause risk of damage to the unit.

	a. Keep the heat pump away from fire source.
	b. It must be placed in well ventilated area, indoor or closed area is not allowed.
	c. Repair and disposal must be carried out by trained service personnel
	d. Vacuumize completely before welding. Welding can only be carried out by professional personnel in service center.

Attention

- a. Please examine the heat pump carefully and confirm whether the product has arrived in a good shape, with fixed screws, and a full range of accessories after you receive the product.
- b. Unpack the heat pump before formally installation by cutting the packing tape, taking off the packaging, and removing the bottom wooden pallet. Plastic packing bags and tapes should be properly handled, and do not let children play with them.
- c. If you suspect a refrigerant leakage, remove or extinguish all open flames around the equipment.
- d. Installation and maintenance of this product must be carried out in a well-ventilated area.
- e. Please install this equipment under local laws, regulations and standards.
- f. A circuit breaker must be installed between the equipment and the user's power supply.
- g. Check the surroundings of the cable to ensure that it is not exposed to abrasion, corrosion, crushing, sharp edges or any other adverse environment. The cable needs to be firmly connected to avoid loosening from constant vibration of compressor or fan, etc.
- h. It should be ensured that the equipment is firmly installed.
- i. If a leakage is found in the pipeline connected to the water inlet and outlet, the equipment needs to be shut down immediately.
- j. Set the proper temperature for a comfortable experience, either overheating or overcooling shall be avoided.
- k. To optimize the heating effect, please install thermal insulation on the water pipes.
- l. A pool insulation cover can be used during the heat pump heating process, which can help improve the heating efficiency of the heat pump.
- m. If a power failure occurs during operation, the heat pump will automatically restart when power is restored.

- n. When the heat pump does not operate properly or reports a fault code, stop operation and contact service personnel.
- o. Only use manufacturer-specified parts for replacement of components.

Waste disposal information

When using this heat pump in the European countries, the following information must be followed:
DISPOSAL: Do not dispose this product as unsorted municipal waste. It is prohibited to dispose this heat pump in domestic / household waste. It is prohibited to dispose this appliance into forests or natural landscape. This could lead into local soil pollution. Collection of such waste must be treated individually.



DISPOSAL POSSIBILITIES:

1. The municipality has established a collection system where electronic waste can be disposed.
2. When buying a new product, the retailer or the manufacturer may take back the old appliance free of charge.
3. Old appliance may contain valuable resources which could be sold to scrap material dealers.
4. Disposal of packaging materials such as carton box or plastic / bubble foil can be recycled.



2. OVERVIEW OF THE HEAT PUMP

2.1. Transportation

- a. When storing or moving the heat pump, always keep it in an upright position.

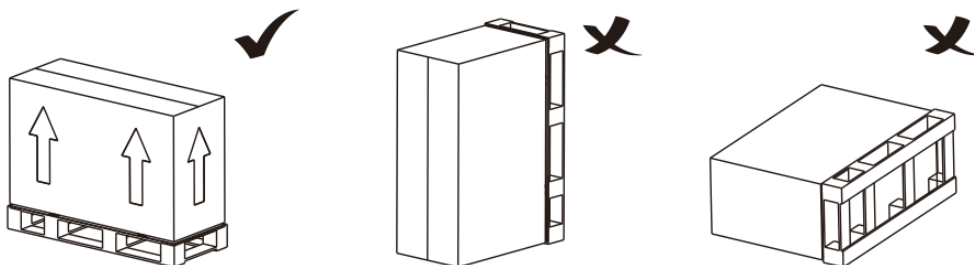

- b. Do not lift up the water union when there is a need to move the heat pump, as it will damage the internal titanium heat exchanger.

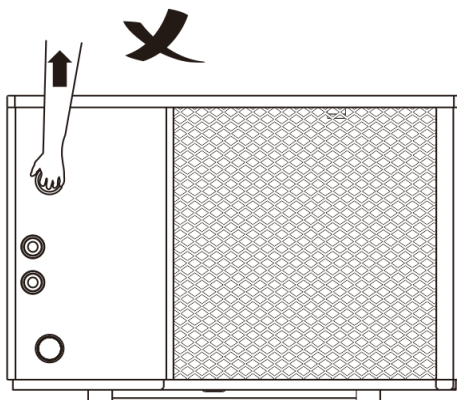

2.2. Accessories

After opening the package, please check that you have all of the following accessories.

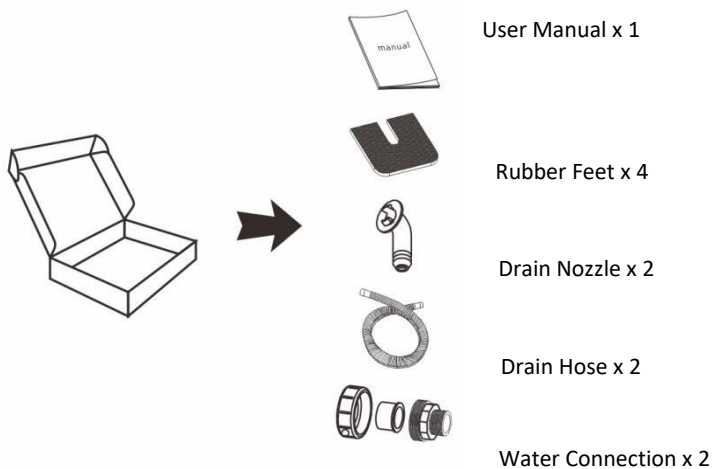

2.3. Technical Parameter

Model No.	USP	HP1100 SILVER INVERTER PRO	HP1500 SILVER INVERTER PRO	HP1800 SILVER INVERTER PRO
Advised Pool Volume	m ³	25~40	35~55	40~60
Performance Condition: Air Temperature: 27°C, Inlet / Outlet Water Temperature: 26°C / 28°C, Humidity 80%				
Heating Capacity	kW	2.97~11.66	3.68~15.56	4.54~18.34
Power Consumption	kW	0.18~1.61	0.22~2.12	0.28~2.57
COP	W/W	16.50~7.24	16.72~7.33	16.21~7.13
Performance Condition: Air Temperature: 15°C, Inlet Water Temperature: 26°C, Humidity 70%				
Heating Capacity	kW	2.52~8.66	2.78~11.62	3.64~13.42
Power Consumption	kW	0.30~1.59	0.33~2.13	0.44~2.48
COP	W/W	8.40~5.44	8.42~5.45	8.27~5.41
Power Supply	/	220-240V~/50Hz		
Operating Air Temperature	°C	-15~43		
Refrigerant	/	R32		
Compressor	/	Mitsubishi		
Fan Motor Type	/	DC		
Water Connection	mm	50		
Noise Level (1m)	dB(A)	36~45.5	38~47	38.5~47.5
Advised Water Flow	m ³ /h	5.0	6.6	7.8
Water Pressure Drop	kPa	15	18	20

*The above data are subject to modify based on continuous improvement without advance notice. Please refer to those on real unit, and thanks for your attention to the latest version.

Model No.	USP	HP2100 SILVER INVERTER PRO	HP2800 SILVER INVERTER PRO
Advised Pool Volume	m ³	45~75	60~100
Performance Condition: Air Temperature: 27°C, Inlet / Outlet Water Temperature: 26°C / 28°C, Humidity 80%			
Heating Capacity	kW	4.78~21.40	5.78~28.54
Power Consumption	kW	0.29~3.00	0.35~3.95
COP	W/W	16.48~7.13	16.51~7.22
Performance Condition: Air Temperature: 15°C, Inlet Water Temperature: 26°C, Humidity 70%			
Heating Capacity	kW	3.64~14.61	4.46~18.84
Power Consumption	kW	0.42~2.68	0.51~3.34
COP	W/W	8.66~5.44	8.74~5.64
Power Supply	/	220-240V~/50Hz	380-415V/3N~/50Hz
Operating Air Temperature	°C	-15~43	
Refrigerant	/	R32	
Compressor	/	Mitsubishi	
Fan Motor Type	/	DC	
Water Connection	mm	50	
Noise Level (1m)	dB(A)	40~50	41~50.5
Advised Water Flow	m ³ /h	9.2	12.2
Water Pressure Drop	kPa	35	38

*The above data are subject to modify based on continuous improvement without advance notice. Please refer to those on real unit, and thanks for your attention to the latest version.

2.4. Unit Dimensions

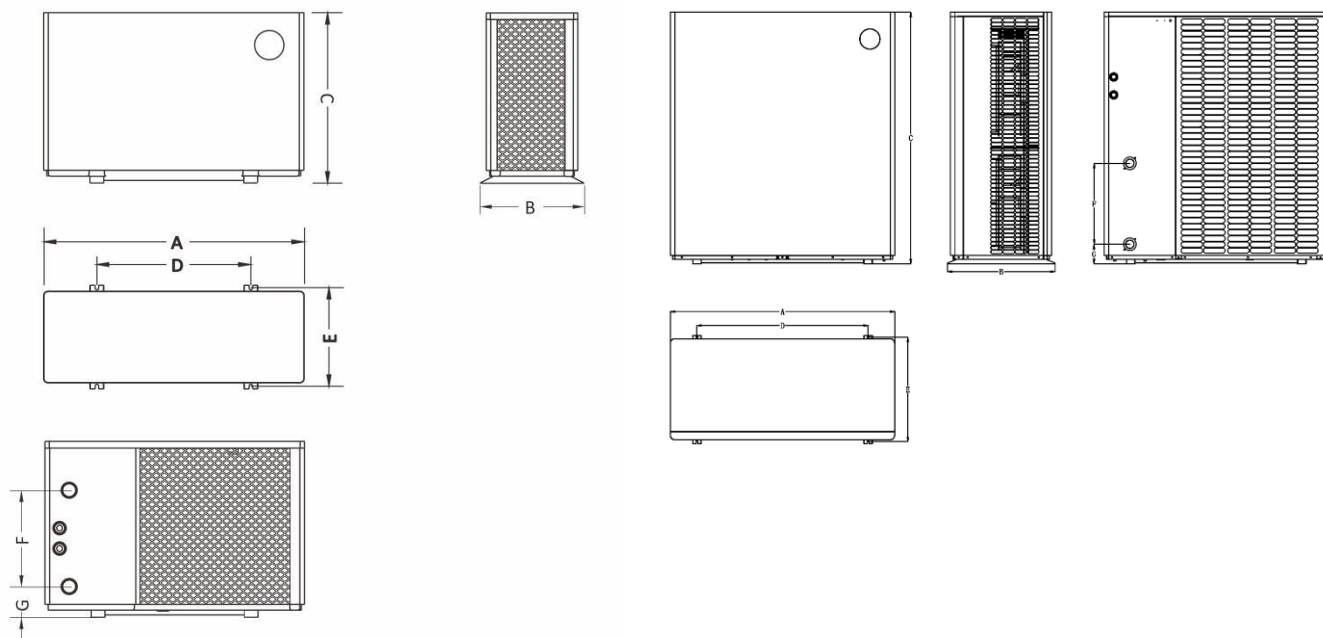

Dimension Indication (unit: mm)

Model	A	B	C	D	E	F	G
HP1100 SILVER INVERTER PRO	1000	460	656	752	436	300	97
HP1500 SILVER INVERTER PRO	1055	490	750	820	470	430	97
HP1800 SILVER INVERTER PRO	1160	530	800	874	510	520	107
HP2100 SILVER INVERTER PRO							
HP2800 SILVER INVERTER PRO	1030	550	1200	794	530	620	107

3. INSTALLATION INSTRUCTION

3.1. Installation Distance

The heat pump should be installed in a well-ventilated area. It should be installed in the place greater than the following distances:

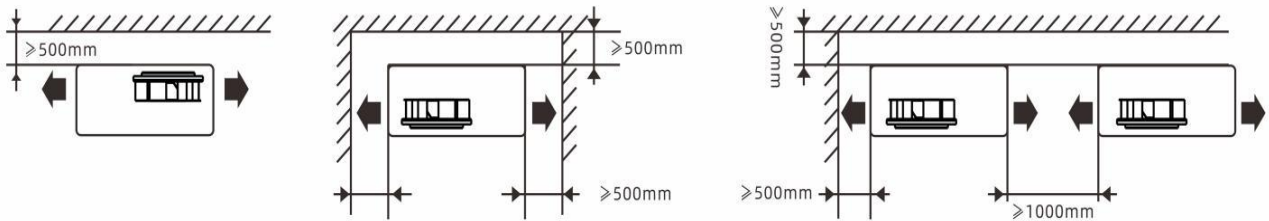

The drain hose needs to be installed in the following manner to the location of the corresponding drainage outlet at the bottom of the heat pump should the installation situation actually requires to guide the drainage. Otherwise leave for free fall.

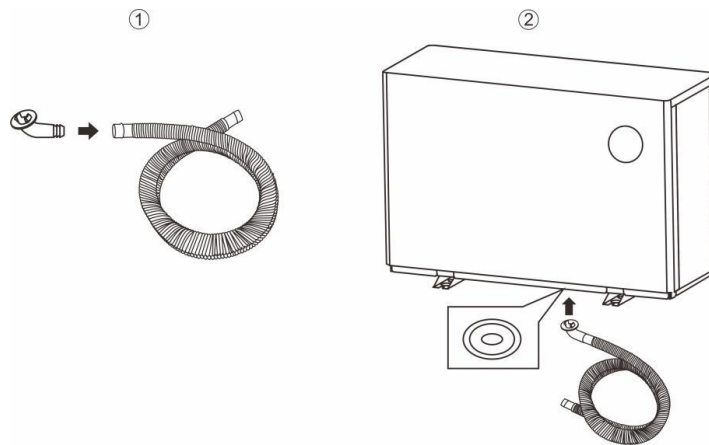

3.2. Installation of Water Connection

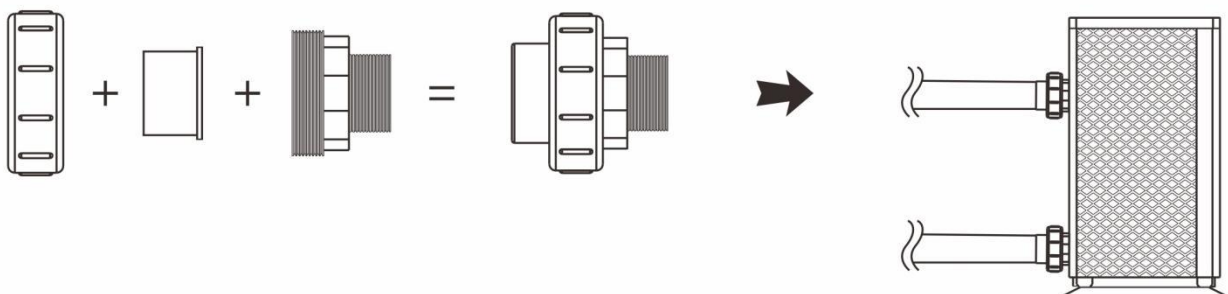

3.3. Installation of Water Pipe - Compact

Use hard pipes rather than soft pipes to connect the water union. Soft pipes will increase the resistance of the pipeline.

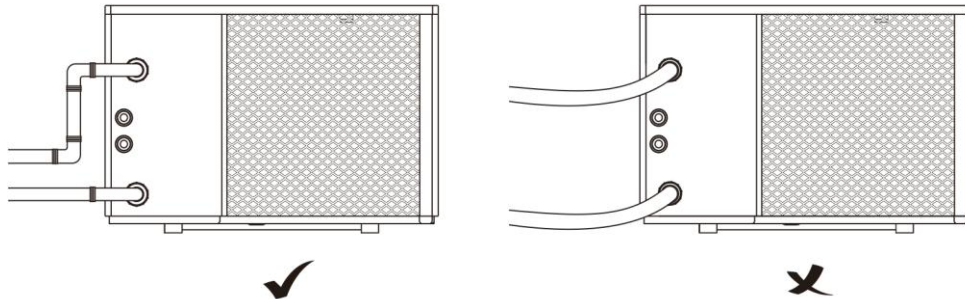

3.4. Layout of Water System

The filter must be routinely cleansed to keep the water in the system clean and to avoid filter clogging. If the operating ambient temperature is below 0°C, please keep the water pump running.

The installation schematic is shown below:

Compact

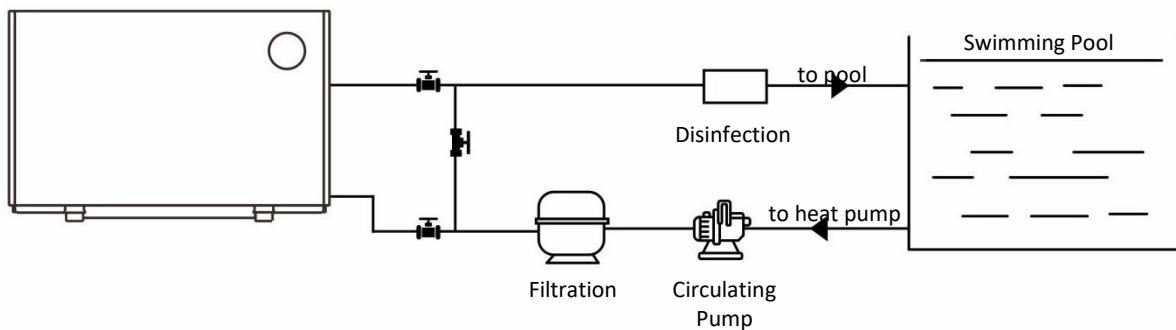

Split

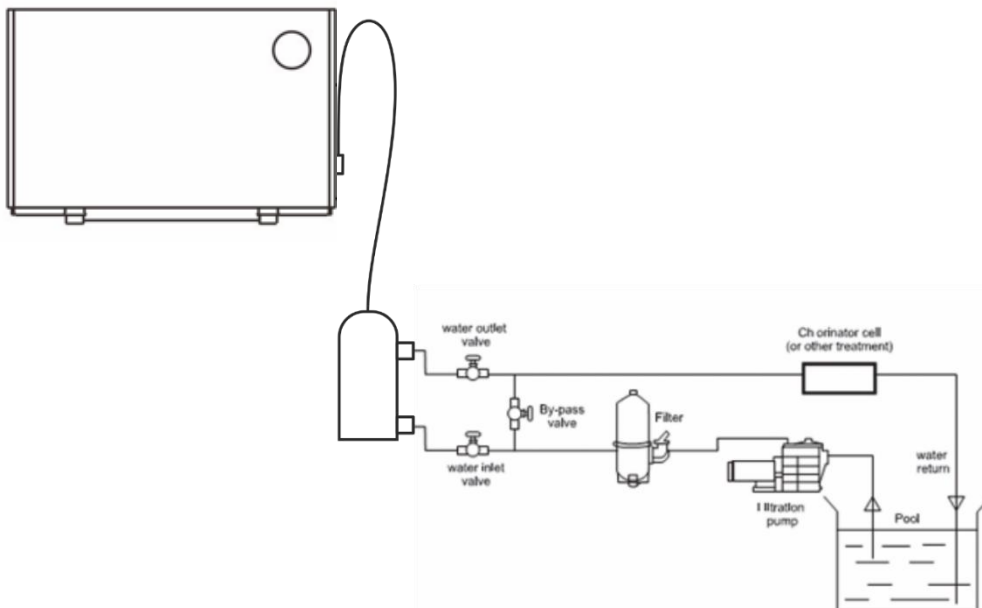

Electrical Installation

a. Attention

For safe operation and to maintain the integrity of the electrical system, the equipment must be connected to a common power supply in accordance with the following provisions:

- ① The heat pump must be connected to a suitable circuit breaker according to the standards and regulations in force in the country/region where the system is installed.
- ② The supply cable must be adapted to the rated power of the equipment and the wiring length required for the installation. The cable must be suitable for outdoor use.
- ③ For three-phase systems, the phases must be connected in the correct sequence. If the phases are reversed, the compressor of the heat pump will not work.
- ④ In places open to the public, an emergency stop switch must be installed near the heat pump.

Model	Max rated current	Power Supply	Main power supply cable (Max. Recommend Value)	Circuit breaker	Split signal cable
HP1100 SILVER INVERTER PRO	10.5A	220-240V~/ 50Hz	3G 2.5mm ²	16A	4x 0.5mm ²
HP1500 SILVER INVERTER PRO	14.5A		3G 4.0mm ²	20A	4x 0.5mm ²
HP1800 SILVER INVERTER PRO	17.3A		3G 4.0mm ²	20A	4x 0.5mm ²
HP2100 SILVER INVERTER PRO	20.0A		3G 4.0mm ²	25A	4x 0.5mm ²
HP2800 SILVER INVERTER PRO	26.9A (3x9)	380-415V/3N~/50Hz	5G 2.5mm ²	16A 3f	4x 0.5mm ²

b. Electricity Connection

WARNING: The heat pump must be disconnected from the power supply before any operation.

Please follow the instructions below to connect the heat pump.

Step 1: Remove the side panel of the equipment with a screw driver for wire connection.

Step 2: Connect the cable wires to the corresponding ports of the heat pump according to the diagram below.

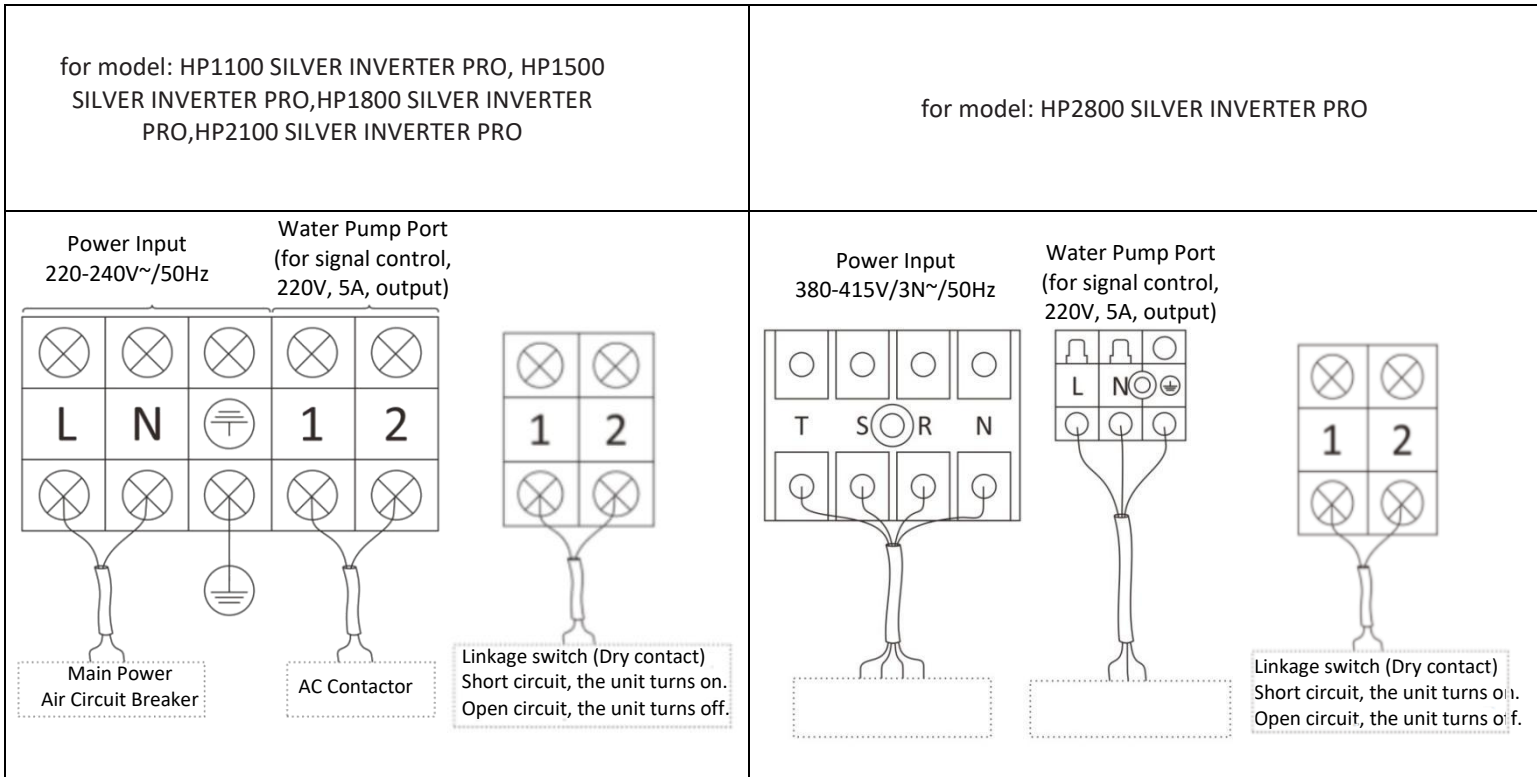

Split – connection between the units

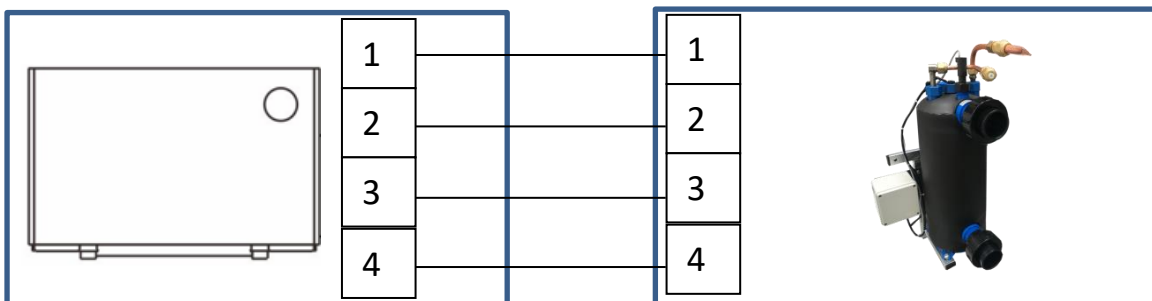

TESTING

WARNING: Check all wiring carefully before turning on the heat pump.

4.1. Inspection

Before trial running, verify that the following items are complied with.

- a. The heat pump is installed properly.
- b. The power supply voltage is the same as the rated voltage of the unit.
- c. Leakage protector is working normally.
- d. Piping and Wiring are connected correctly.
- e. The ground wire is connected correctly.
- f. The air inlet and outlet of the unit are unobstructed.
- g. Smooth drainage and no water leakage.
- h. Pipe insulation is completed.
- i. Air in the pipe has been evacuated.

4.2. Trial Running

Step 1: The user must turn on the water pump first and then turn on the heat pump. Turn off the heat pump first, and then turn off the water pump. Otherwise the machine will be damaged.

Step 2: Before starting the heat pump, check for any leaks of water and set the proper temperature, then turn on the power.

Step 3: Items to check during trial running.

- ① Whether the electric current is normal.
- ② Whether there's leakage of the whole gas system.
- ③ Whether the buttons of the controller are normal.
- ④ Whether the display screen is normal.
- ⑤ Whether there is abnormal noise or vibrations during operation.
- ⑥ Whether the condensate drainage is normal.



5. Touch controller

5.1. Icon and Key Description of Wire Controller







5.1.1. Icon Description







No.	Icon	Meaning of Icon	Function Description
1		Smart Mode	It will display under Smart Mode.
2		Silent Mode	It will display under Silent Mode.
3		Boost Mode	It will display under Boost Mode.
4		Heating Mode	It will display under Heating Mode.
5		Cooling Mode	It will display under Cooling Mode.
6		Defrosting Mode	It will display under Defrosting Mode.
7		Auto Mode	It will display under Auto Mode.
8		Clock/Timer/Parameter	Clock Display/Timing On-Off/Parameter
9		Fault Display	It will display when faults occur.
10		Electric Heater Icon	It will display when electric heating is on.
11		Wi-Fi Connection	It will flash during Wi-Fi connecting and display after successfully connected.

12		Locked	It will display if the wire controller is locked.
13		Degree Celsius	It will display when the temperature is set to be in Degree Celsius.
14		Degree Fahrenheit	It will display when the temperature is set to in Degree Fahrenheit.

5.1.2. Key Description



No.	Key	Key Meaning	Function Description
1		Mode 1	Short press to switch between auto/cooling/heating modes when the power is on.
2		Mode 2	Switch to Smart/Silent/Boost Mode
3		Up	Increase the Setting Value
4		Down	Decrease the Setting Value
5		Power	Short press to turn On/Off the heat pump. Long press 3 seconds to lock/unlock the wire controller.

5.1.3. Combination Keys Description

No.	Combination Keys	Function Description
1	Long Press “  ” and “  ” for 2 Seconds	Enter Parameter Checking Interface
2	Long Press “  ” and “  ” for 2 Seconds	Enter Timer Setting Interface
3	Long Press “  ” and “  ” for 3 Seconds	Search for a Wi-Fi Signal and Connect to Wi-Fi

5.2. Operation Instruction of Wire Controller





5.2.1. Power

Short press the “” key to turn the heat pump on or off. Long press the “” for 3 seconds to lock/unlock the wire controller. The wire controller locking mode activates automatically after 120 seconds of inactivity. When the wire controller is locked, the icon “” appears.





5.2.2. Mode

a. Heating/Cooling/Auto

When the heat pump is on, short press “” key to select the operating modes (Auto, Cooling and Heating). The circular selecting sequence is Auto→Cooling→Heating→Auto...

Note: The icon “” will be displayed under Auto mode. The heat pump intelligently chooses the most appropriate operating mode according to the setting temperature: When it is running into Auto Heating mode, “” and “” will be displayed; When it is running into Auto Cooling mode, “” and “” will be displayed.

Smart/Silent/Boost





When the heat pump is on, short press “” to switch between  Boost/  Silent /  Smart mode.

 Boost→ Smart→ Silent (modes switch in circular sequence)



5.2.3. Temperature Setting



When the heat pump is on, short press “” or “” keys to adjust the setting temperature under current mode. Press “” “” and hold longer than 0.5 seconds for rapid adjustment.

5.2.4. Wi-Fi Connection

Long press “” and “” together for 3 seconds to connect to Wi-Fi. The icon “” will be flashing during connecting. After successfully connected, the icon “” will be displayed.

5.2.5. Check Operating Parameters

(1) Enter Parameter Checking Interface: Long press “” and “” together for 2 seconds to enter the parameter checking interface. Parameter code is shown in the timing display area, and parameter content is shown in the temperature display area.

(2) Parameter Checking Method: After entering the parameter interface, short press “” or “” to check the operating parameters. Short Press “” to exit the interface, or it exits automatically if no operation for 60 seconds.

Operating Parameter List

Code	Parameter Name	Unit	Scope	Remark
01	Practical frequency of inverter compressor	Hz	0~150	
02	AC current	A	0~50	
03	AC voltage	V	0~300	
04	DC voltage	V	0~500	
05	Inlet water temperature	°C	-30~150	
06	Outlet water temperature	°C	-30~150	
07	Water tank temperature	°C	-30~150	Not for pool heat pump
08	Tube in shell heat exchanger temperature	°C	-30~150	Not for pool heat pump
09	Outdoor coil temperature	°C	-30~150	
10	Outdoor ambient temperature	°C	-30~150	
11	Gas suction temperature	°C	-30~150	

12	Gas exhaust temperature	°C	0~150	
13	Water inlet temperature of plate heat exchanger	°C	-30~150	Not for pool heat pump
14	Outlet water temperature of titanium heat exchanger	°C	-30~150	Not for pool heat pump
15	Step of electronic expansion valve in main circuit	P	0~500	Number of pulses
16	Step of electronic expansion valve in auxiliary circuit	P	0~500	Not for pool heat pump
17	IPM (driver module) temperature	°C	0~150	Reserved (default value: -30)
18	DC fan motor speed	RPM	0~900	

5.2.6. Faults Display

When the fault occurs, the corresponding fault codes flash in the timing area and the icon “

Fault Code List

Fault code	Description	Remark
E01	IPM (driver module) protection	
E02	AC voltage over/shortage protection	Input voltage inspection
E03	AC current over high protection	
E04	Gas exhaust temperature over high protection	
E05	Outside coil temperature over high protection	
E06	Compressor drive protection	
E07	Ambient temperature sensor fault	
E08	Outside coil temperature sensor fault	
E09	Gas exhaust temperature sensor fault	
E10	Bus voltage over/shortage protection	Voltage protection after rectification
E11	Current sensor fault	
E12	Compressor driver communication fault	





E13	DC fan motor fault	
E14	Gas suction temperature sensor fault	
E15	Driver’s EE fault	
E16	Main control board’s EE fault	
E17	Low pressure protection	
E18	High pressure protection	
E19	IPM temperature over high protection	
E20	Power off suddenly	Automatic power on after recovery
E21	Evaporation temperature (T2) over low protection	
E22	Communication error between wired controller and main control board	
E23	Phase-shortage protection	
E24	Inlet water temperature sensor fault	
E25	Outlet water temperature sensor fault	
E26	Water flow switch fault	This fault is activated also during circulation pump inactivation, i.e. no water flow.
E27	Inadequate water flow protection	
E28	Outlet water temperature over high protection at heating mode	
E29	Outlet water temperature over low protection at cooling mode	
E30	Evaporation temperature sensor (T2) fault	
E33	PFC hardware F0 error	Driver error
E34	PFC software over current protection	Driver error
E35	Compressor step-lost	
E37	Compressor startup failure	

5.2.7. Clock Setting

(1) Enter Clock Setting: Long press the “” key for 3 seconds till the digit in hour part flashes,

and then it will enter the clock setting interface.







(2) Clock Setting Method: Flashing means adjustable. When the digit in hour area is flashing, press





“” or “” to adjust Hour; Press “” to switch to Minute part and repeat above actions. When finishing setting, press “” to save the setting and press “” to exit setting interface.



5.2.8. Power ON/OFF Timer Setting

(1) Users can set up two groups of ON/OFF timers with adjustable ON and OFF time respectively. If the timer of power ON and OFF are set to the same, the setting will become invalid.

(2) Power ON/OFF Timer Setting Method



Long press “” and “” for 3 seconds till the icons “” and “1” are displayed on the right side of the screen. When the icon “1” is flashing, press “” or “” to select group no.1 or group no.2, and then press “” to confirm.

When the digit in Hour area is flashing and the “ON” icon is displayed, press “” or “” to set the hour of timing ON of group no.1(or no.2). Press “” to confirm and turn to set the minute while the digit in Minute area is flashing. Repeat above actions and press “” to confirm.

(3) When the group no.1(or no.2) timing ON setting is finished, it will automatically turn to the timing OFF setting interface. When the icons “1”(or 2) and “OFF” are displayed, press “” or “” to set the hour of timing OFF of group no.1(or no.2). Press “” to confirm and turn to



set the minute while the digit in Minute area is flashing. Repeat above actions and press “ ” to confirm.

Note: Short pressing the “” key during the operation will exit the timing setting and the setting parameters will no longer be saved. Or long press the “” key for 3 seconds during operation, then the current timing setting will be canceled.

(4) Exit Timing ON/OFF Setting: During setting, short press “” will abandon the current setting and exit the setting interface.

(5) Cancel Timing ON/OFF Setting: When entering timer group no.1(or no.2) setting interface, long press “” for 3 seconds to cancel the timer group no.1(or no.2).

5.3. Operation Instruction of Wi-Fi Function

5.3.1. APP Download

Search “Smart Life” or directly scan below QR code to download.

 Smart Life	APPLE system download from:	ANDRIOD system download from:	Or scan below QR code to download:
			

Note: For Android mobiles, “Download apps from external sources” should be activated, as below shows:

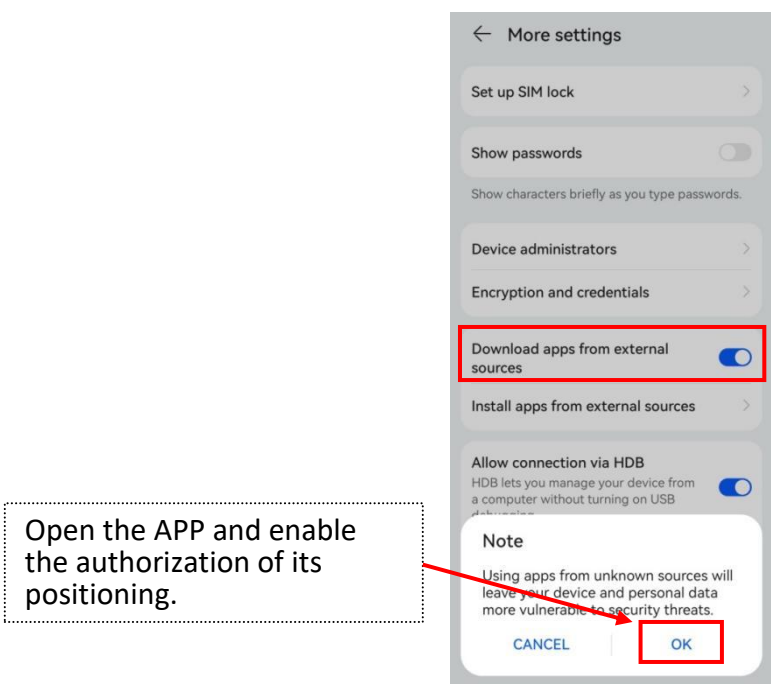

5.3.2. User Registration

(1). New users need to register at the first time use.

(2). Finish your registration according to the instruction.

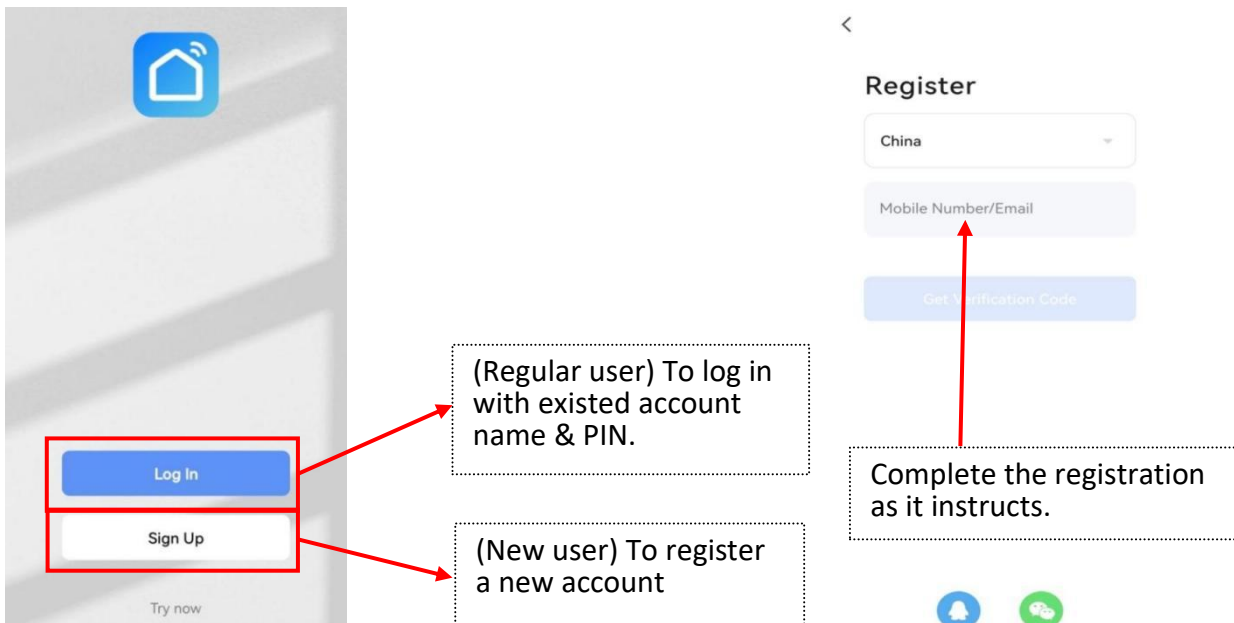

5.3.3. User Login

Select your location, enter the account name and PIN, and need to agree the Privacy Policy.

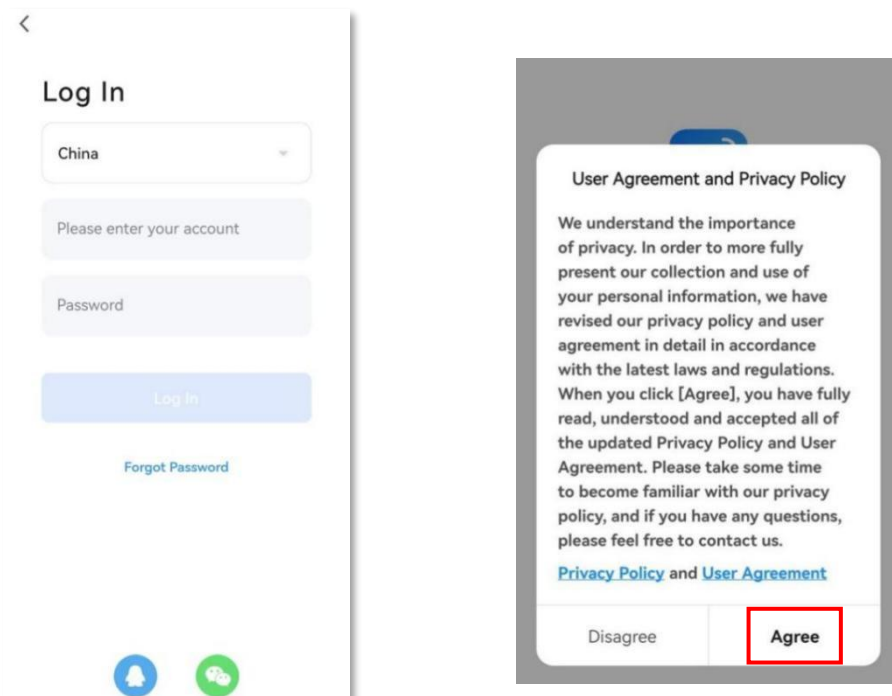

Connect your smartphone to the available Wi-Fi (the same Wi-Fi source as the heat pump device connects). And also keep your smartphone Bluetooth open in the meanwhile.

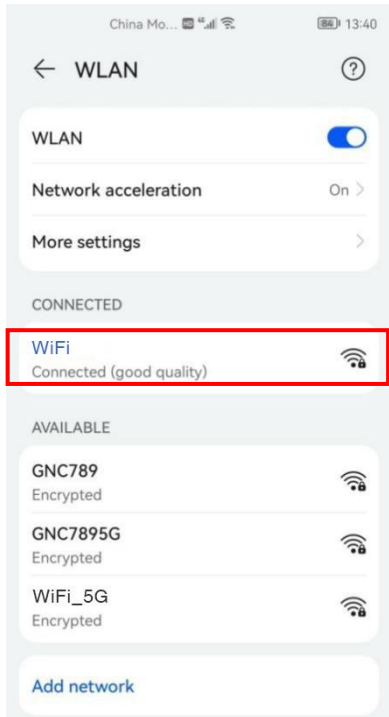

Ensure your smartphone Location Services remain "On" and also turn on "Allow Apps to Request to Track" :

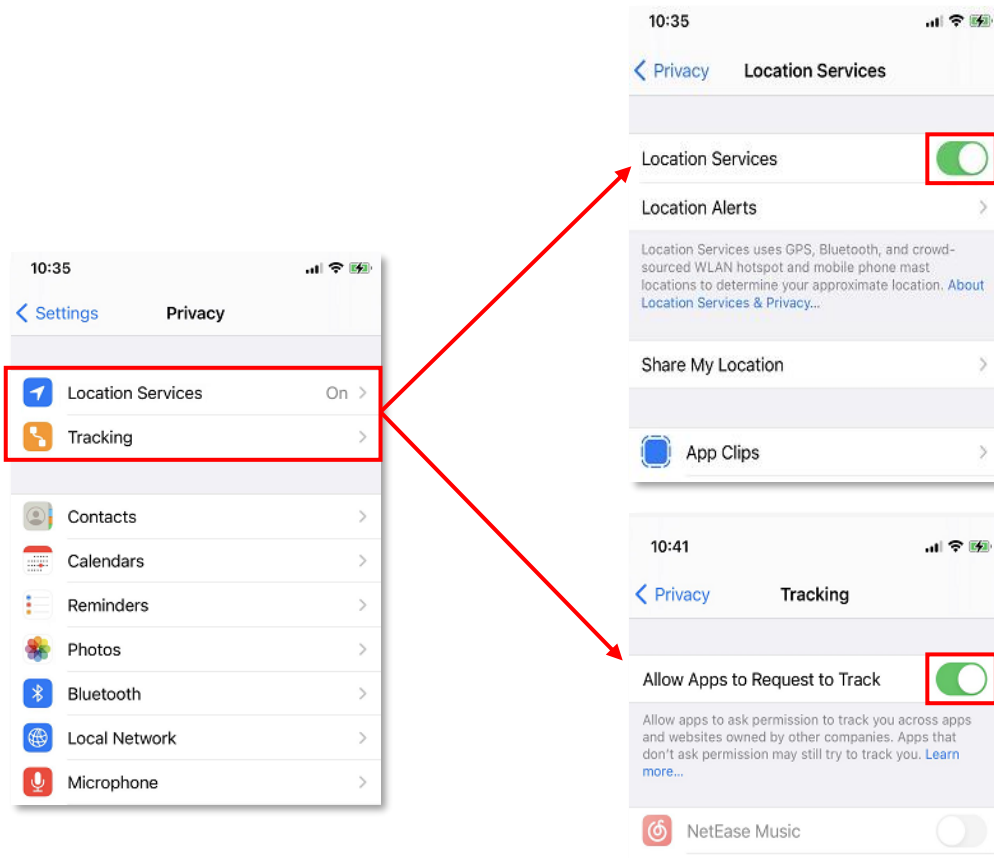

5.3.4. Add Device

Tap “+” at the right upper corner, or tap “Add device” button to add the smart devices you want to connect.

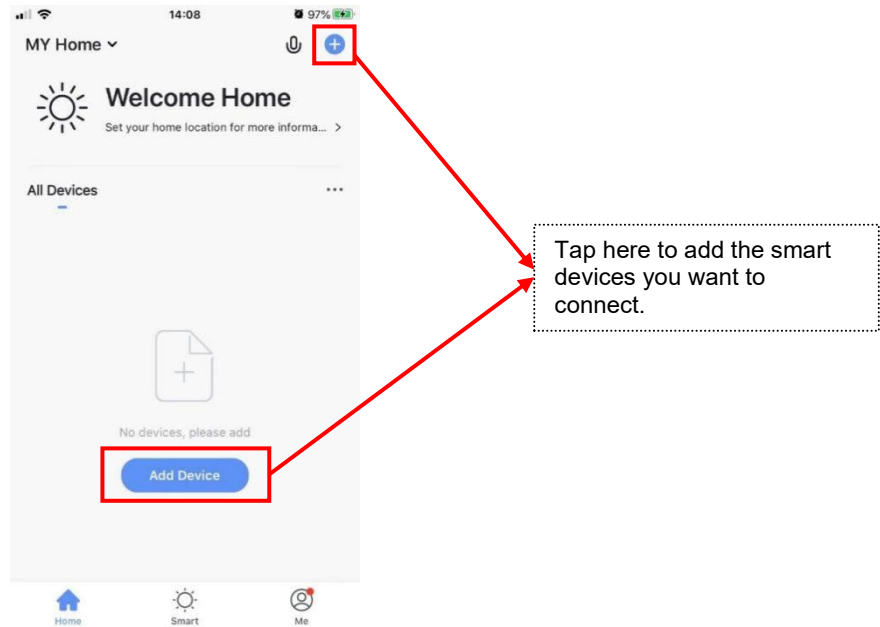

Select “Others” to enter the “Add Manually” interface. And then select “Others (Wi-Fi)”.

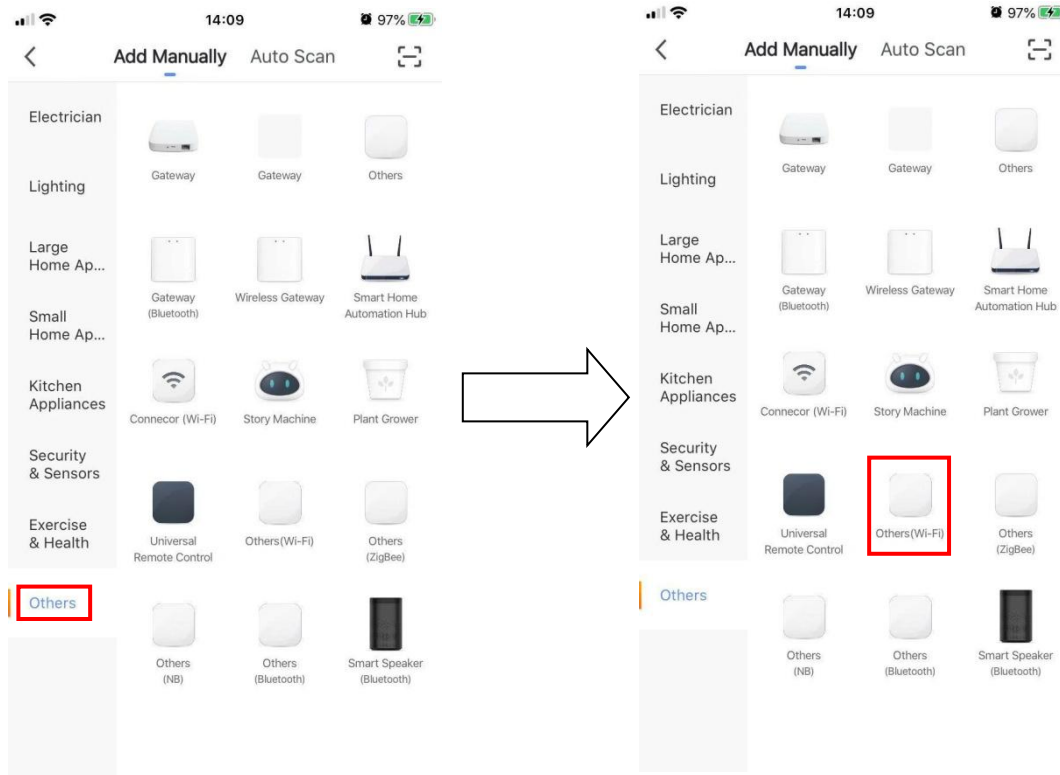

Then enter this below interface and need to input Wi-Fi account & Wi-Fi password (the same Wi-Fi source as the heat pump device connects):

After inputting above information , tap the “Next” button.

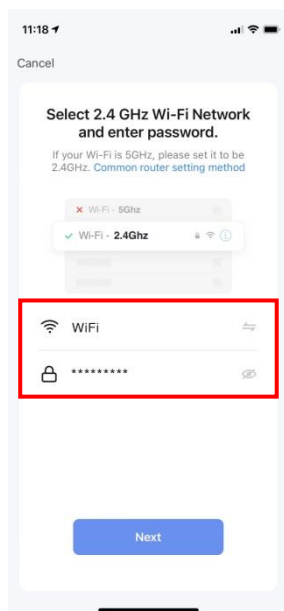

5.3.5. Connection

When you enter this interface , please tap button below.

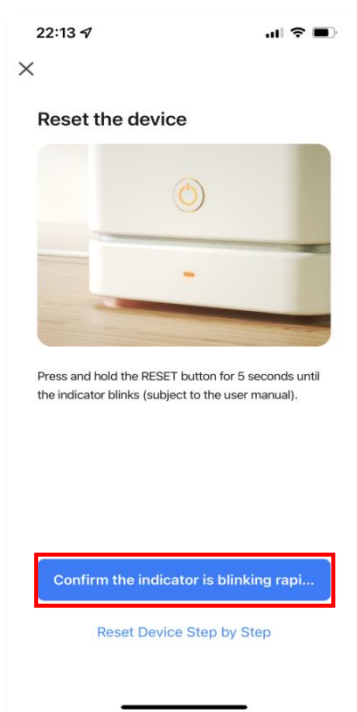

Then, operate the controller of heat pump like this below :

Using your fingers to press on these two buttons **M** and  at the same time until the “Wi-Fi” icon starts flashing.

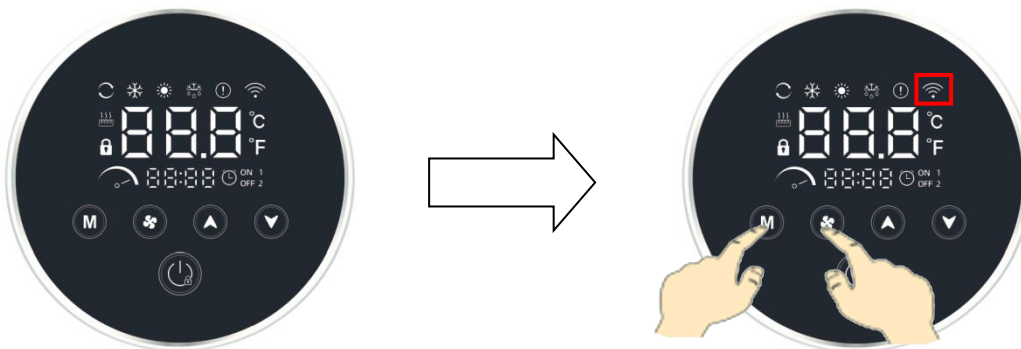

Scene 1:

If the icon of Wi-Fi flashes slowly on heat pump controller, please tap the “Blink Slowly” button on your mobile phone.

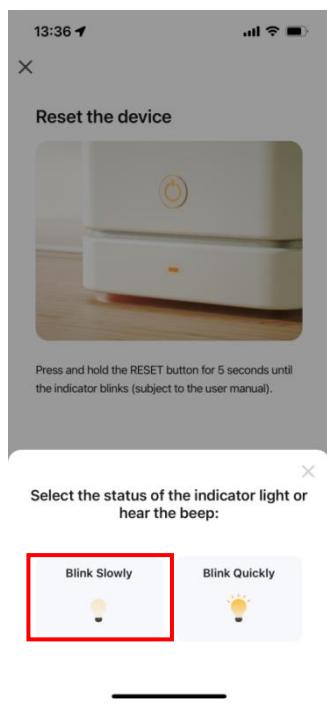

Enter into this interface and then tap the button below.

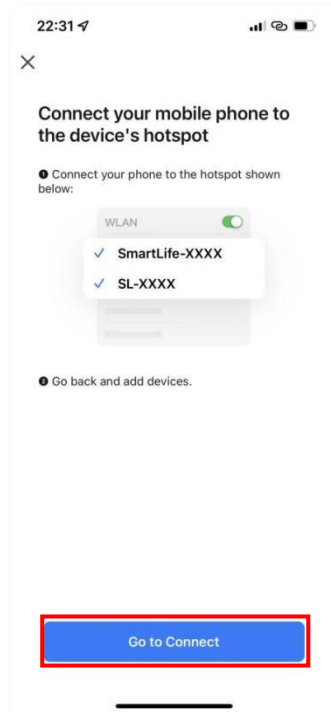

Select the WLAN source of "SmartLife-XXXX" ("XXXX" will be random combination of letters and numbers). And then get back to the Smart Life app.



When below page comes up, it means your mobile phone is searching the hot spot signal from heat pump controller.

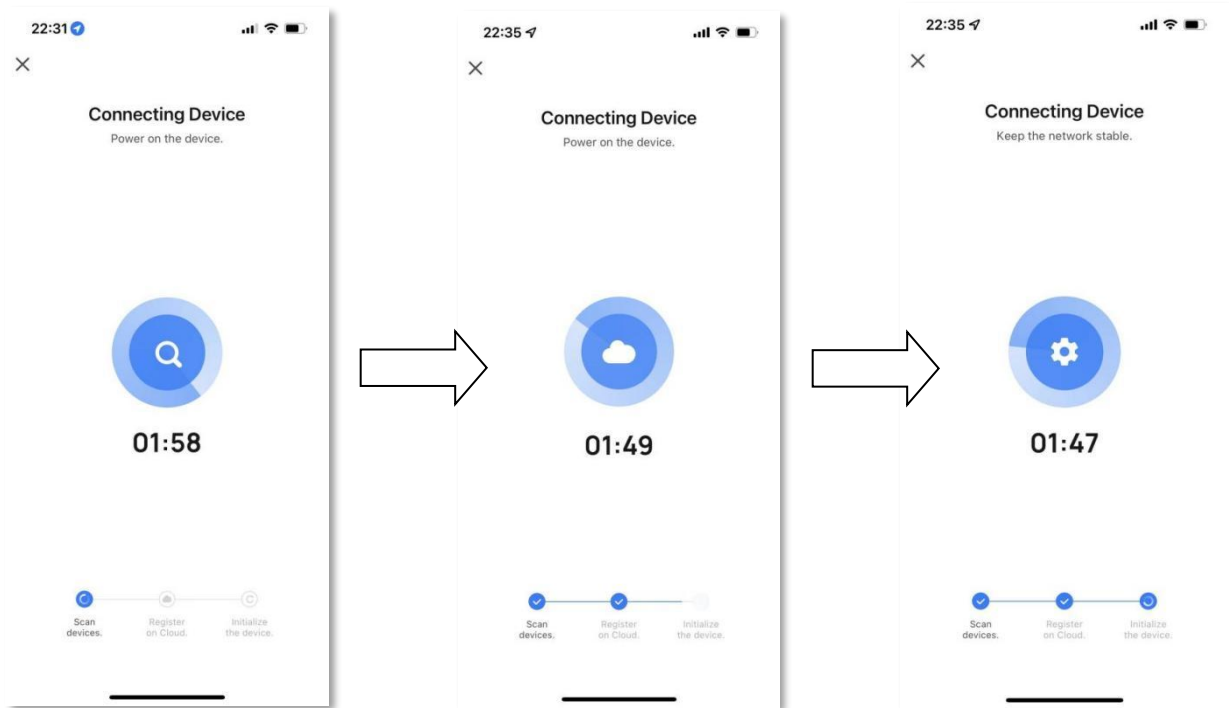

When this page comes up, it means the connection is successful. Then tap the “done” button to enter the Wi-Fi control interface.

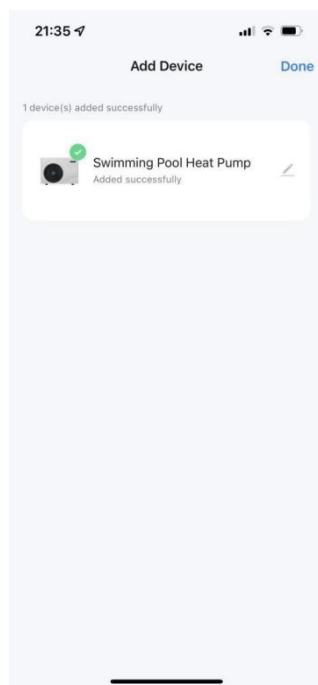

Scene 2:

If the icon of Wi-Fi flashes rapidly on heat pump controller, please tap the “Blink Quickly” button on your mobile phone.

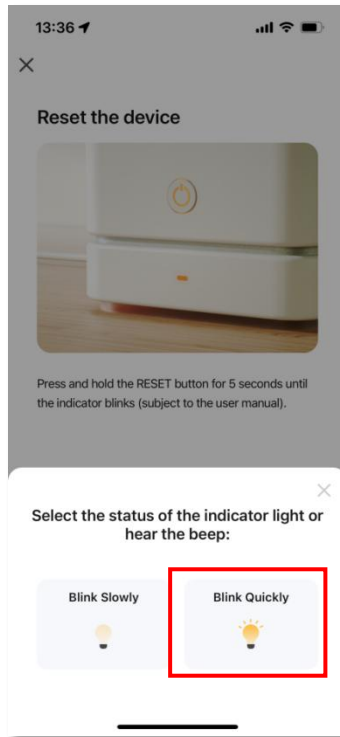

Enter into this interface and then tap the following “+” button. After the connection is successful, tap the “done” button to enter the Wi-Fi control interface.

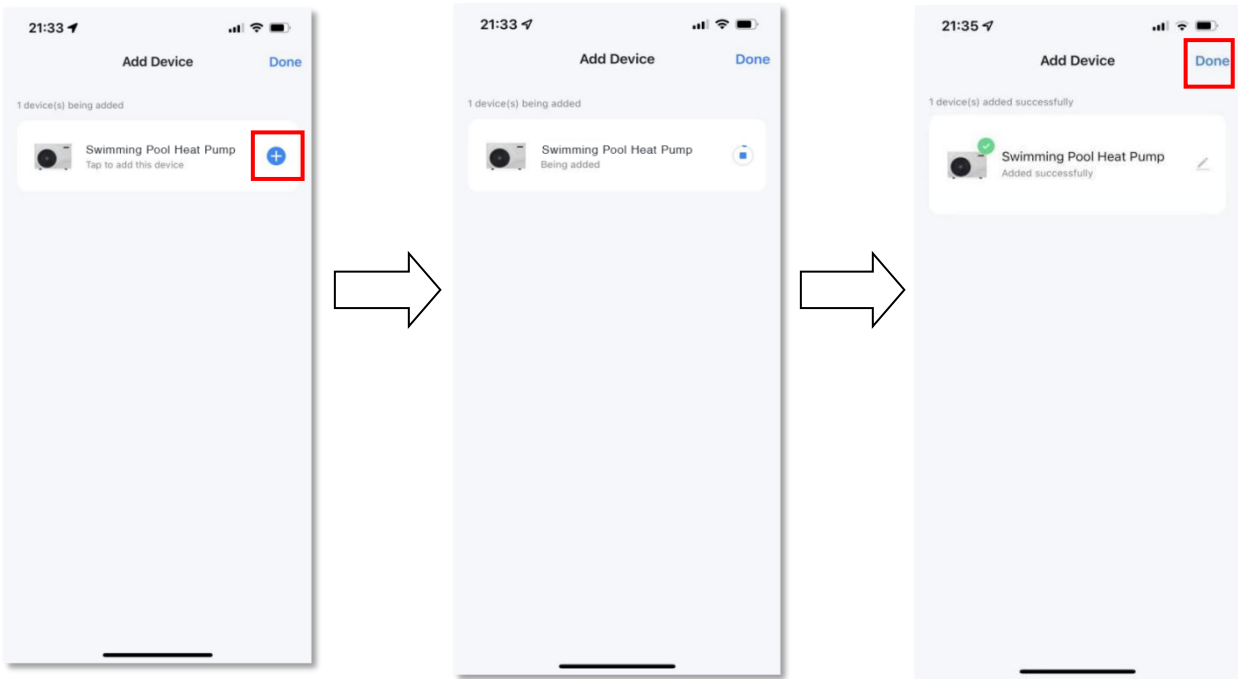

5.3.6. Wi-Fi Control Interface

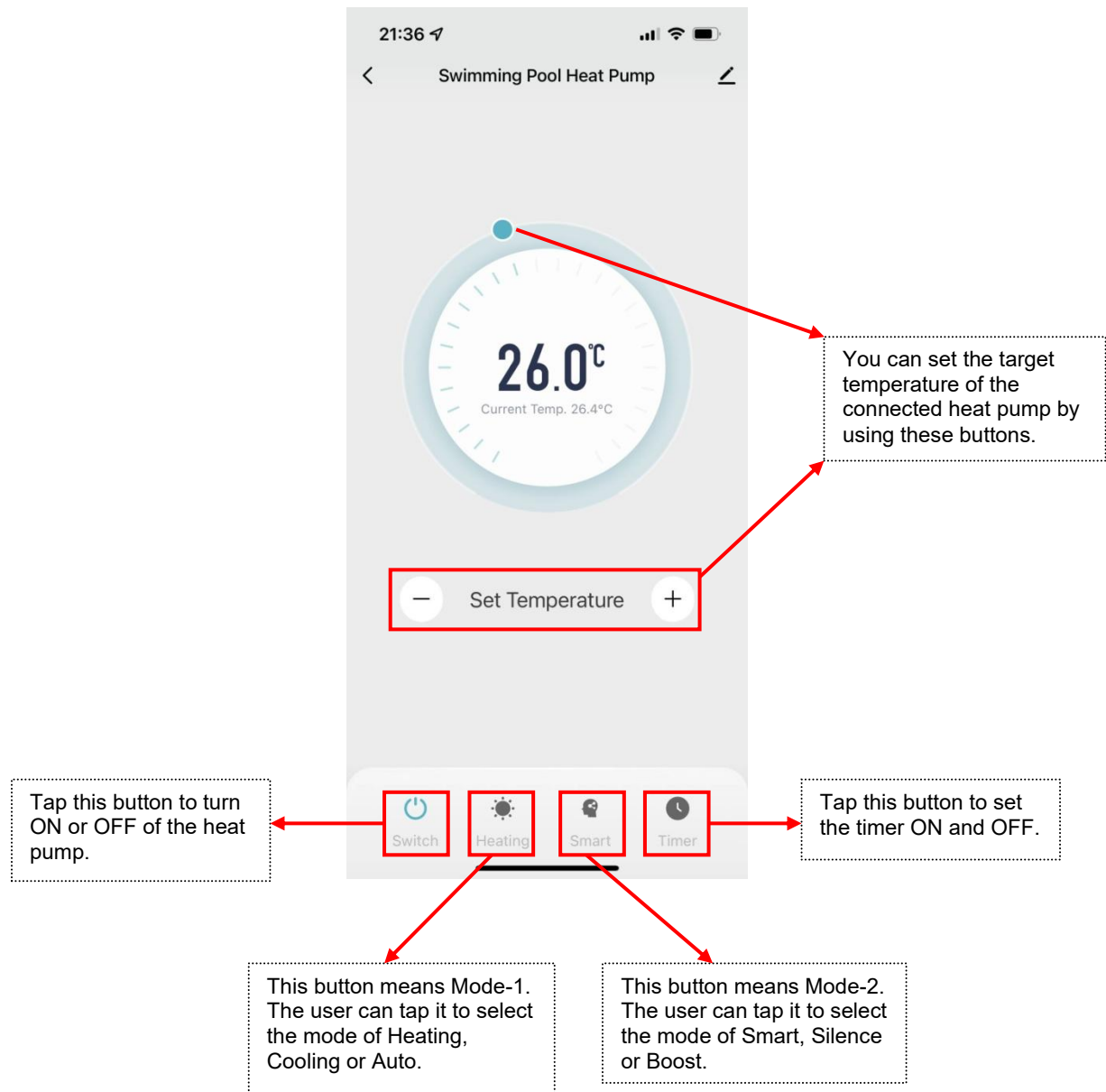

5.3.7. Share Device to Your Family Members

After connection, if your family members also want to control the heat pump, please let them register “Smart Life” first, and then the administrator can operate as below to share the device:

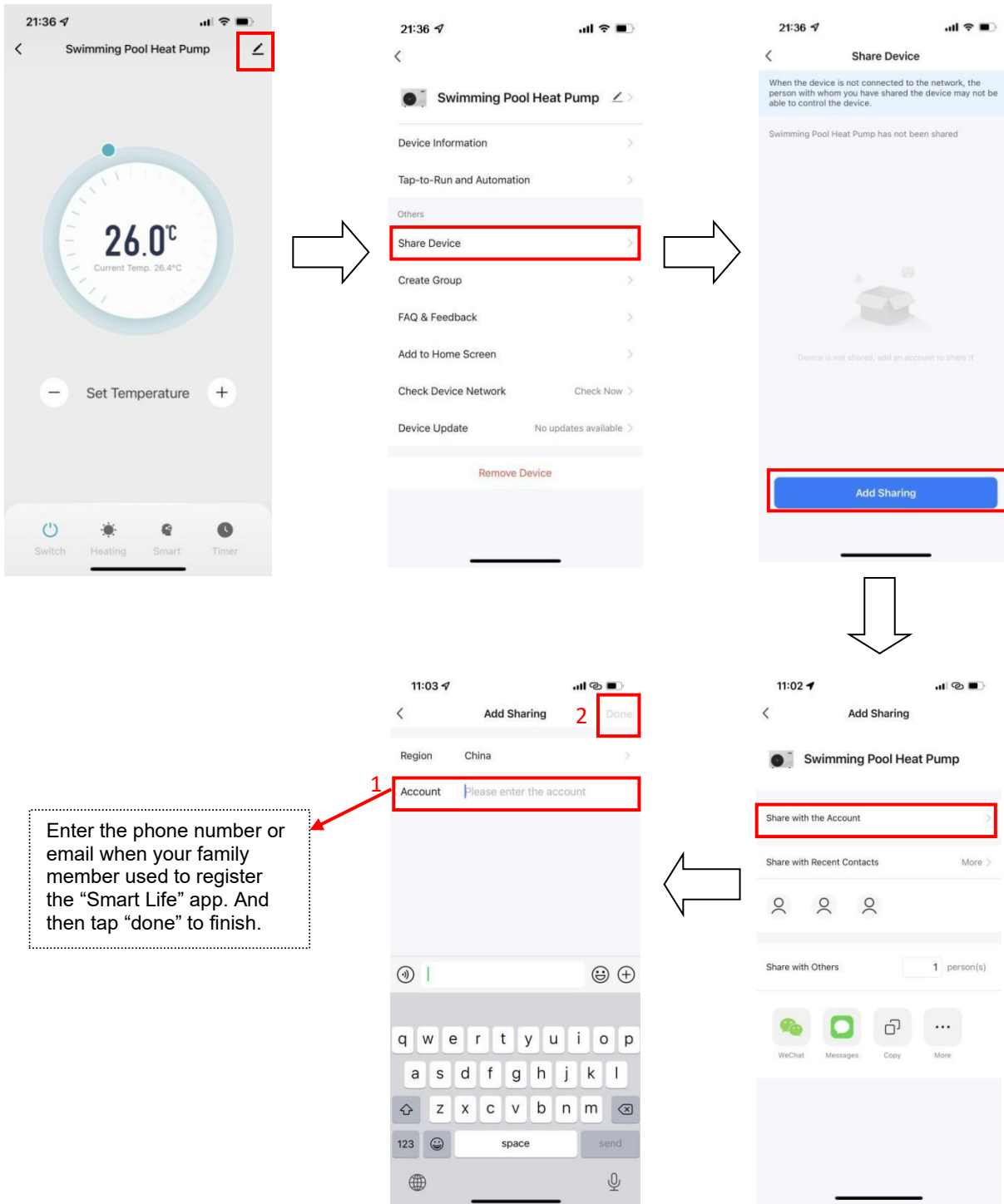

Remark: The app is subject to updates without notice.

5. SPLIT - connection and installation

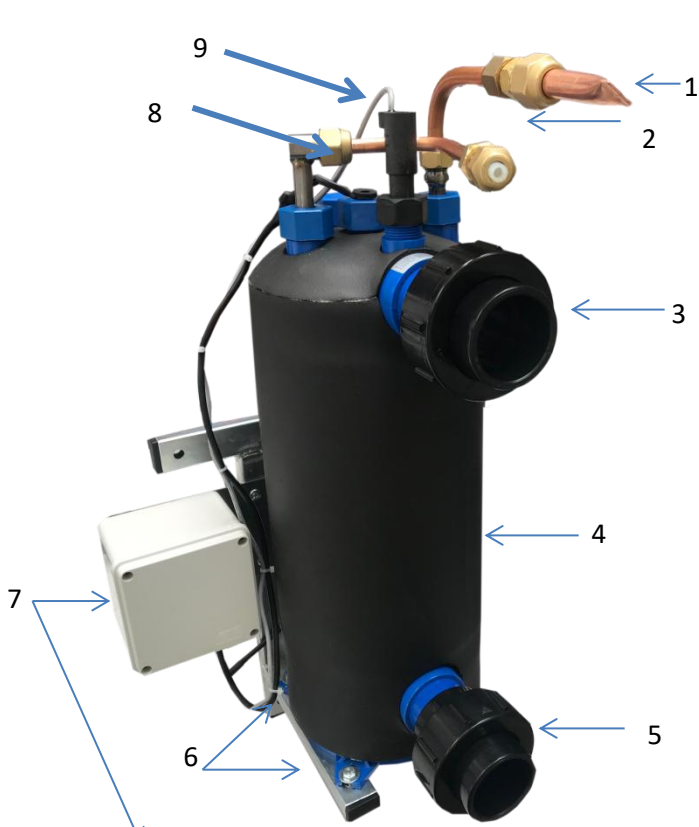

- 1. Gas R32
- 2. Gas R32
- 3. Water OUT
- 4. Heat exchanger body
- 5. Water IN
- 6. Screws fixing the exchanger on console 4x
- 7. Electro connection compartment
- 8. Water out sensor
- 9. Flow switch
- 10. Water in sensor
- 11. Fixation holes for screws to fix the console on a wall 4x
- 12. Main electrical connection of the condensing unit
- 13. Condensing /compressor / unit
- 14. Gas R32
- 15. Gas R32
- 16. Interconnecting cable /on demand/

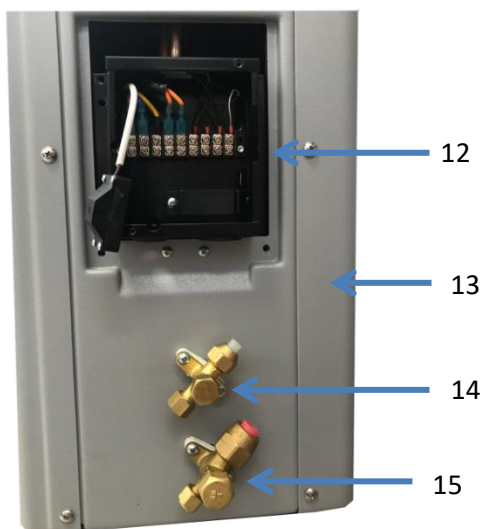
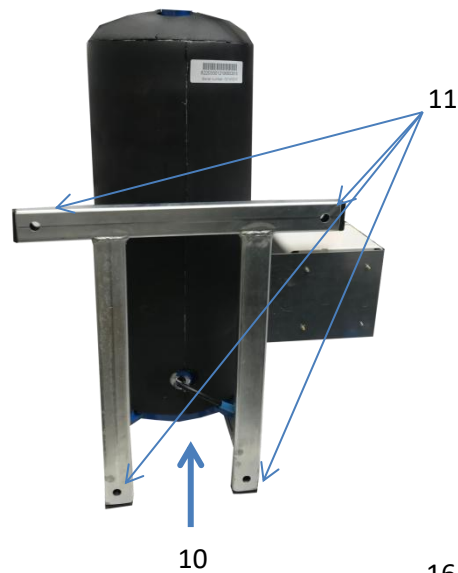

Refrigerant circuit connection

Split heat pump requires refrigerant circuit connection in order to operate normally. This is normally done during installation of the pump as the pump comes with separate (not connected) condensing and water units refrigerant-wise originally from the factory. Refrigerant circuit must be sealed.



IMPORTANT: Please note that refrigerant connection can be performed by an authorized person only. The person must have a valid refrigeration license. Relevant directives: 573/2024/EU, 303/2008/EU and 2024/2215/EU.

Condensing unit is pre-charged with refrigerant R32 from the factory.

Piping length and elevation

Heat pump model	Pipe size				Factory pre-charged connection distance	Nominal charge g R32	Max. vertical distance (B)	Max. distance (A)	Additional refrigerant for 1m (above 2m)	Maximum charge g R32
	Gas (diameter)		Liquid (diameter)							
	inch	mm	inch	mm						
HP1100	1/2	12.70	1/4	6.35	0m	600g	15m	25m	25g/m	1.225g
HP1500	5/8	15.88	3/8	9.52	0m	800g	15m	25m	35g/m	1.675g
HP1800	5/8	15.88	3/8	9.52	0m	850g	15m	25m	45g/m	1.975g
HP2100	5/8	15.88	3/8	9.52	0m	1150g	15m	25m	45g/m	2.275g
HP2800	3/4	19.05	3/8	9.52	0m	1350g	15m	25m	60g/m	2.850g

Water unit

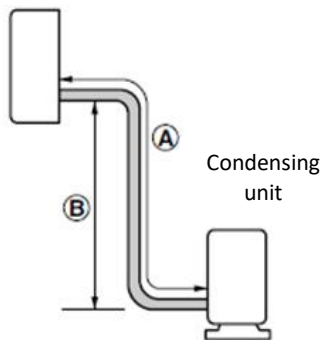

Condensing unit

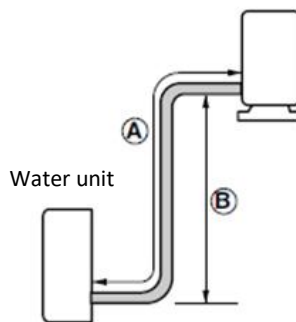

Siphon trap min. 500mm!!!

Refrigerant piping – condensing unit

1. Align the center of the pipings and sufficiently tighten the flare nut by hand. Please do so for both gas and liquid pipes.

Gas pipe has bigger diameter.

Liquid pipe has smaller diameter.

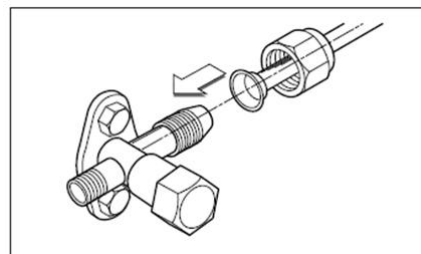

2. Tighten the flare nuts with torque wrench until the wrench clicks. Please make sure that the direction for tightening follows the arrow on the wrench.

Please review below table for torque force.

Please use refrigerant copper pipes with insulation only.

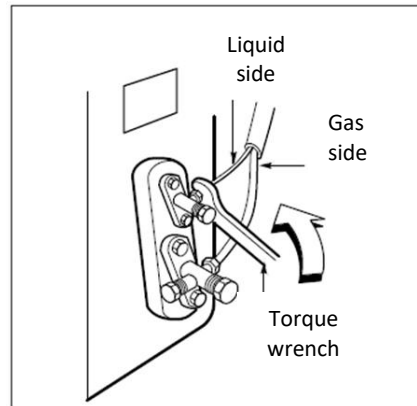

Outside diameter		Torque kgf m
inch	mm	
1/4	6.35	1.8-2.5
3/8	9.52	3.4-4.2
1/2	12.7	5.5-6.6
5/8	15.88	6.3-8.2

3. Forming and insulation the piping.

The pipes must be insulation and secured with vinyl tapes. This is done in order to prevent condensation on the piping.

It is highly advised to place the piping into a plastic protector when installed in the ground (soil).

On places where piping goes through a wall or similar it is advised to use gum type sealer or construction foam to seal the openings.

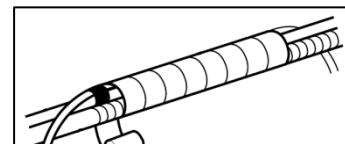
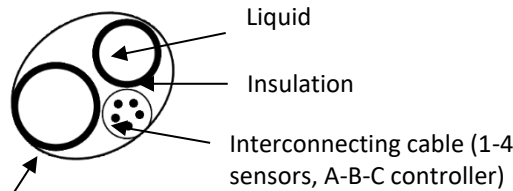

3.1. Condensing unit below water unit

Tape the piping and interconnecting cable from down upwards. Fix the tapped piping with cable binder or equivalent onto the exterior wall. It is important to make a trap to prevent water from entering into the electro installation of the condensing unit.

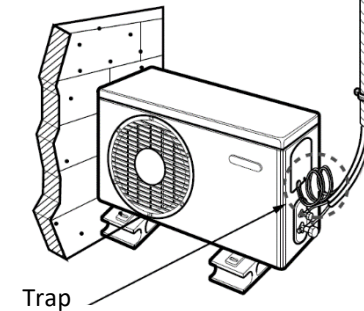

3.2 Condensing unit above water unit

Tape the piping and interconnecting cable from down upwards. Fix the tapped piping with cable binder or equivalent onto the exterior wall. It is important to make a trap to prevent water from entering into the electro installation of the condensing unit. On refrigerant side it is important to form a syphon.

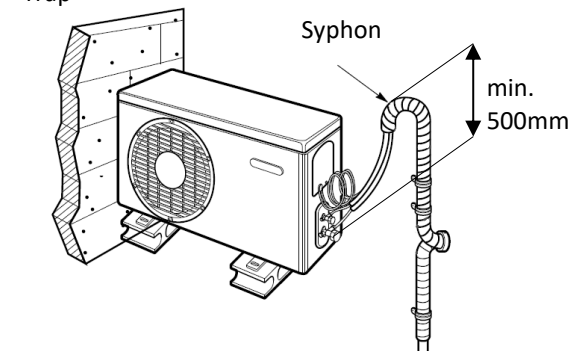

Flaring work

It is important to perform the flaring work correctly. This will have positive effect towards long-term reliability and functionality of the heat pump. Defective or incorrect flaring work is the most common cause for gas leakage. Gas leakage results in continuous decrease of heat pump efficiency and eventually leads into security turning off, malfunction, failure or damage.



Warranty does not cover any product, property or personal damages or losses that are a result of incorrect flaring work, gas leakage, incorrect welding work or improper material used.



When cutting the pipes and cables, please mind the following:

1. Measure the distance between the water and the condensing unit.
2. Cut the pipes a little longer than measured distance.
3. Cut the cable 1.5m longer than the pipe length.

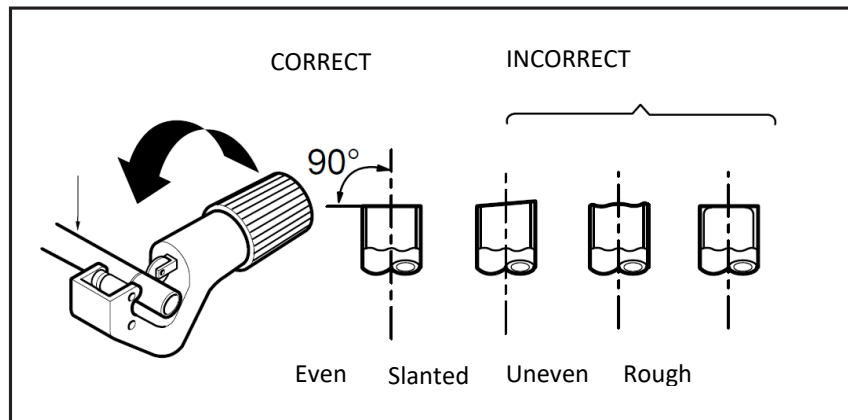

Smooth, shiny without scratches

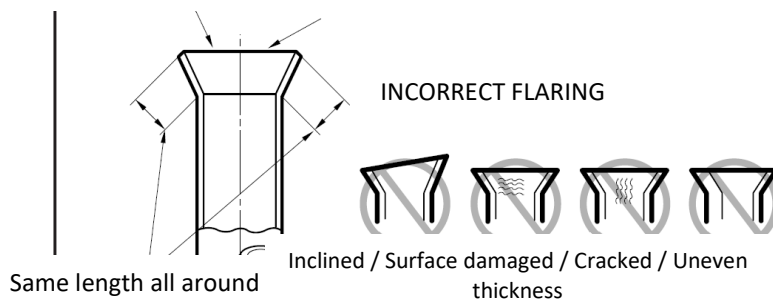

Same length all around

Inclined / Surface damaged / Cracked / Uneven thickness

Pressure test / Air purging

Sometimes bits of air and moisture remains in the refrigerant circuit. If this is not treated, following symptoms may appear on your heat pump:

1. Pressure in the system rises.
2. Operating current rises.
3. Heating or cooling efficiency drops.
4. Blockage of capillary tube due to frozen moisture resulting in complete failure of the heat pump.
5. Corrosion of refrigerant circuit.

It is thus highly advised to take a leak test after evacuating the complete system. Leak test can be performed with usual methods using manifold valve and/or soap water. Air purging can be performed by most

commonly applied methods with vacuum pump. This Installation and user manual elaborates vacuum pump method.



When the condensing unit is pre-charged with refrigerant we do not recommend a pressure test using nitrogen.



Air purging with vacuum pump

1. Preparation
 - a. Check that each tube (both liquid and gas) between the water and condensing units have been properly connected and all wiring for the test run has been completed.
 - b. Remove the service valve caps from both the gas and the liquid side on the condensing unit. Please note that both the liquid and the gas side service valves on the condensing unit are kept closed at this stage. Some heat pumps models have in their refrigerant circuit only 1 service valve installed.
2. Lead test by vacuuming
 - a. Connect the charge hose end described in the preceding steps to the vacuum pump to evacuate the tubing and water unit. Confirm the "Lo" knob of the manifold valve is open. Then, run the vacuum pump. The operation time for evacuation varies with tubing length and capacity of the pump. The following table shows the time required for evacuation when using a vacuum pump of 30 gal/h power.

Required time for evacuation when 30 gal/h vacuum pump model is used	
Tube length less than 10m	Tube length more than 10m
Minimum 10 minutes	Minimum 15 minutes

- b. When the desired vacuum is reached, close the "Lo" knob of the manifold valve and stop the vacuum pump.

Finishing the job

1. With a service valve wrench (inbus wrench), turn the valve stem of liquid side valve counter-clockwise to fully open the valve.
2. Turn the valve stem of gas side valve counter-clockwise to fully open the valve.
3. Remove the charging hoses.
4. Put service valve caps back at both gas and liquid side service valves and fasten them tight. This completes air purging with a vacuum pump and refrigerant works.

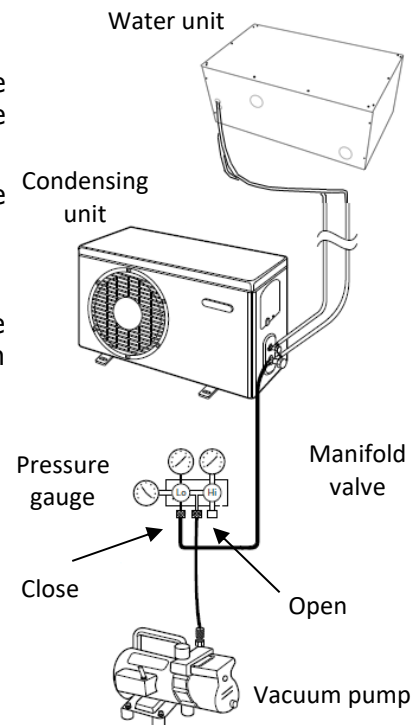

Please note that above flaring and refrigerant work must be performed correctly with utmost care. Any non-compliance with above may and will likely lead into heat pump's malfunction, failure or damage. Such state means complete warranty void and manufacturer; distributor or reseller cannot be taken responsible in such case for any property or personal damage or loss.

Water unit dimensions SILVER INVERTER PRO in mm

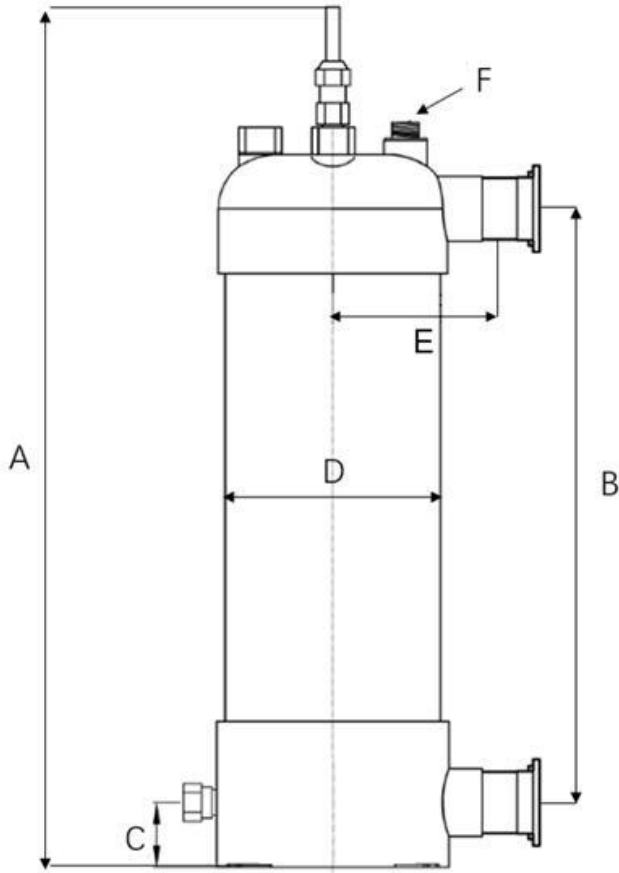

Model	A	B	C	D	E	F
HP1100	504	300	70	140	-	3/4
HP1500	614	430	70	140	100	3/4
HP1800	687	520	80	160	100	3/4
HP2100	687	520	80	160	100	3/4
HP2800	787	620	80	160	102	3/4

6. MAINTENANCE AND WINTERIZING

6.1. Maintenance

WARNING: Make sure the power supply is cut off before any maintenance work is performed on the unit.

① Cleaning

- a. Please clean the machine with household cleaners or water. Do not use gasoline, thinner or any similar fuel.
- b. The finned-tube heat exchanger at the rear of the heat pump must be carefully cleaned using a vacuum cleaner and soft brush.

② Annual Maintenance

The following operations must be performed by qualified personnel at least once a year. Do not attempt to work on the equipment by yourself. Improper operation may cause danger.

- a. Conduct safety checks.
- b. Check the connection and integrity of the wires.
- c. Check the bolts and screws for looseness.
- d. Check the ground connection.
- e. Monitor for refrigerant leaks.

6.2. Winterizing

WARNING: Cut off the power supply of the heat pump before cleaning, inspecting and repairing.

In winter when you don't swim:

- a. Cut off the power supply to prevent any damage to the unit.
- b. Drain the water from the machine. Unscrew the water connection of the inlet pipe and let the water flow out. When water freezes in the machine in winter, it may damage the titanium heat exchanger. Warranty does not cover such damages.

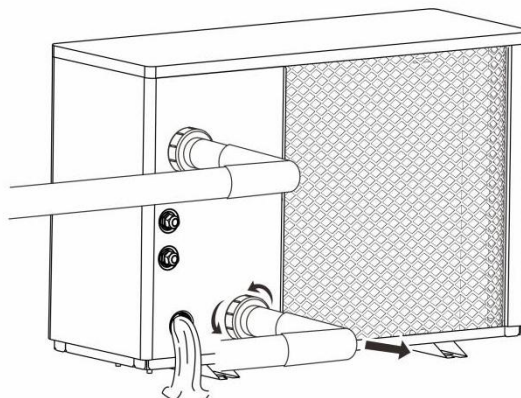

Cover the heat pump with a winter cover when not in use.



Split version of the heat pump in principle is designed for year-round operations. Water unit of the unit heat pump is typically placed in space such as technical or plant room. Split heat pump does not require winterizing, draining of water for the winter if the location of its installation is in constantly above zero temperatures.

Warranty

Your heat pump is covered by warranty. For particular conditions of this warranty in terms of warranty period and subject please refer to your local regulations and/or agreement with your distributor, reseller or installer. Any action resulting in damage of the heat pump, property or other damage caused by improper usage of this product or in contrary with this Installation and user manual is excluded from warranty coverage.

Distributed by:

Manufacturer:



MICROWELL, spol. s r.o.
SNP 2018/42, 927 01 Sala,



Slovakia
tel.: +421/31/702 0540



fax: +421/31/702 0542
e-mail: microwell@microwell.sk
www.microwell.eu