

DRY X

Designed for indoor pools, wellness centers, spas, and hotels



WHERE WATER MEETS TECHNOLOGY POWERED BY X-FLOW

- Cutting-Edge Dehumidification Technology
- Energy-Efficient Design – Lower Operational Costs
- User friendly control panel – built for swimming pool environment
 - Ultra Quiet – Whisper-level operation for spas and hotels



APPLICATION



*These are not real photos, just visualizations.

OPERATING MODES

Dehumidification with heat recovery

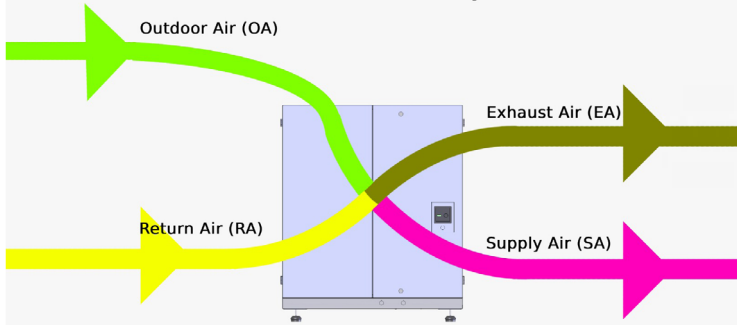

Dehumidification with bypass

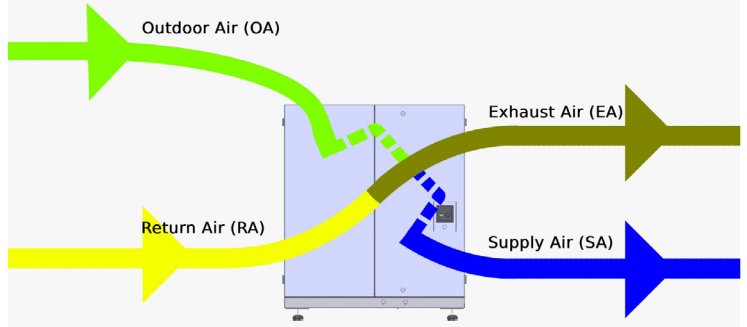

Air heating and filtration by Recirculation

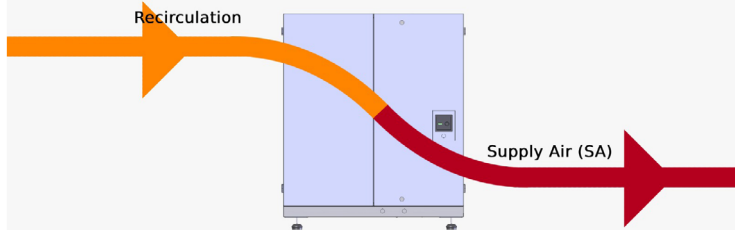

Dehumidification, air heating and filtration by Mixing

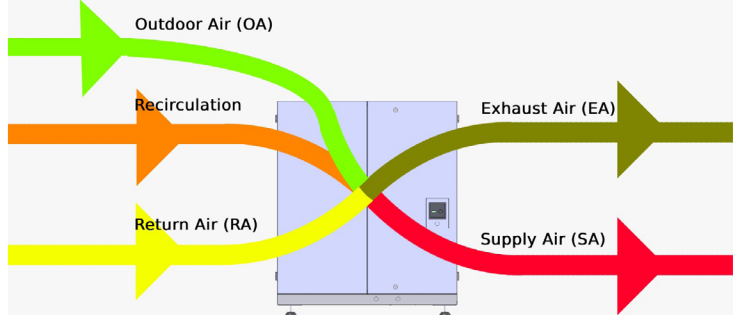

AIRFLOW AND EXTERNAL PRESSURE CHARACTERISTICS DRY X 1200 PRO

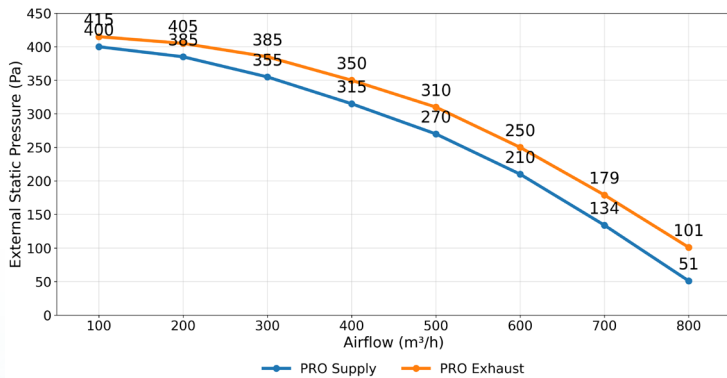

AIRFLOW AND EXTERNAL PRESSURE CHARACTERISTICS DRY X 1200 ECO

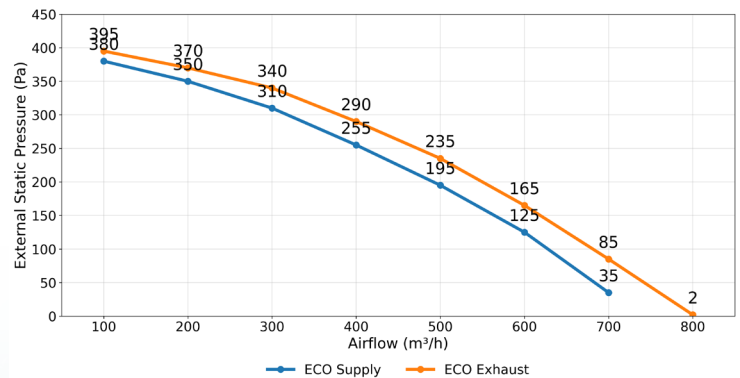

BUILT FOR EXTREME ENVIRONMENTS

Pool halls, coastal areas, commercial kitchens, or chemical facilities? Heat exchangers with Airfin 100 epoxy surface treatment and a fully powder-coated casing provide long-lasting protection and reliable performance.

- ▶ Corrosion resistance tested according to ASTM B117
- ▶ Salt-spray resistance (NaCl 5% / 35°C) — up to 1,000 hours
- ▶ Solvent resistance: trichloroethylene (85°C / 5 min), tetrachloroethylene (120°C / 30 min)
- ▶ Technical specifications identical to standard aluminium heat exchangers

PRO

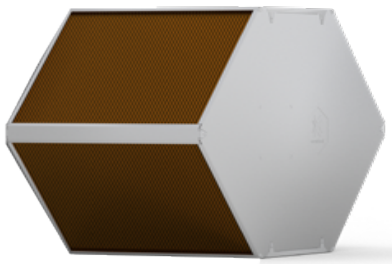

Counterflow, aluminium body with aluminium fins, epoxy GoldFin

ECO

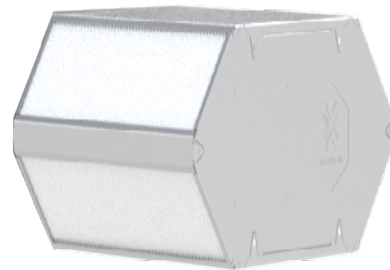

Counterflow, aluminium body with plastic HPS fins

CERTIFICATION



PRODUCT SIZE

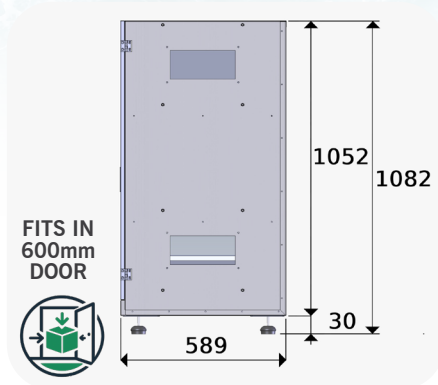
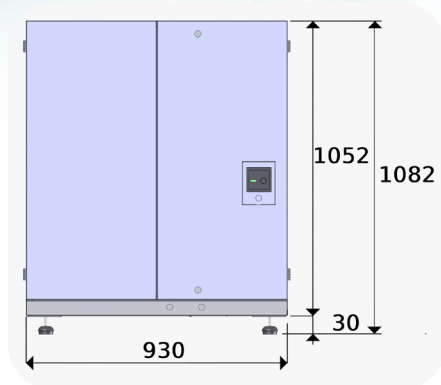

* Dimensions are in mm.

CONTROLLER

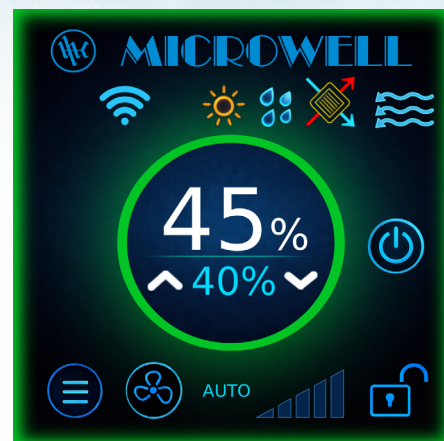

TECHNICAL DATA

Parameters	DRY X 1200 PRO	DRY X 1200 ECO
General application	Humidity and air temperature control + ventilation for pools / wellness	
For swimming pools with max. water surface	150m ²	
Specific use	Unit with higher resistance to chlorine, salt and other elements, designed primarily for public pools and wellness	Unit with excellent resistance to chlorine, salt and other elements, designed primarily for private pools and wellness
Rated airflow for dehumidification	PRO 595 m ³ /h at external static pressure 210 Pa	ECO 595 m ³ /h at external static pressure 165 Pa
External static pressure available	375 Pa at 595 m ³ /h (including unit and filters)	
Maximum airflow	935 m ³ /h	800 m ³ /h
Daily dehumidification capacity Exterior (10 °C, 70% RH) / Interior (30 °C, 60% RH)	166 l/24h	
Daily dehumidification capacity Exterior (10 °C, 70% RH) / Interior (30 °C, 80% RH)	252 l/24h	
Amount of fresh air	0-100 %	
Fan type	EC, low-speed, quiet, 2 pcs	
Rated electrical input, per fan (1 pc)	103 W	
Power supply	230 / 50 V /Hz	
Operating / maximum current of the unit without electric heater	1.5A	
Maximum current with 1.5 kW preheater	7 A	
Sound power level LwA	49 dB(A)	51 dB(A)
Sound pressure level (1 m) at reduced airflow (65%) LpA	39 dB(A)	42 dB(A)
Maximum sound pressure level (1 m), BOOST mode LpA	46 dB(A)	50 dB(A)
Heat exchanger	Counterflow, aluminium body with aluminium fins, epoxy GoldFin	Counterflow, aluminium body with plastic HPS fins
Control	Digital, touchscreen display, Wi-Fi	
Supply air filtration (hygienic)	F7 (ISO ePM1 55%)	
Recirculation air filtration (technical)	G4 (ISO Coarse 65%)	
Unit weight	80 kg	70 kg
Dimensions (W × H × D)	930mm × 1082mm × 589mm (height without mounting feet: 1052 mm) (fits into 600mm door)	
SEC-W (ErP)	-79,8 (A+) kWh/m2.a	-76,5 (A+) kWh/m2.a
SEC-A (ErP)	-41,1 (A) kWh/m2.a	-38,9 (A) kWh/m2.a
SEC-C (ErP)	-16,4 (E) kWh/m2.a	-14,7 (E) kWh/m2.a

The manufacturer reserves the right to alter the technical data without prior notice. Remarks: * The data above is only for reference. For specific data, please refer to the nameplate on the unit.